User Manual

SG60KTL PV Grid-connected Inverter



About This Manual

This manual is for string inverter SG60KTL (hereinafter referred to as inverter unless otherwise specified). The inverter is grid-connected, transformer-less, robust and of high conversion efficiency. We hope the inverter will satisfy you when you use it with your PV plant system.

Aim

This manual contains information about the inverter, which will provide you guidelines to connect the inverter into the PV power system and how to operate the inverter.

Related Documents

The manual cannot include all information about the PV system. You will get additional information at www.sungrowpower.com or via webpage of the manufacturer.

Target Group

This manual is for technical personnel who is responsible for inverter installation, operation and maintenance and inverter owner who will perform daily LCD operation.

How to Use This Manual

Read the manual and other related documents before any work on the inverter. Documents must be stored carefully and available at all times.

All rights reserved including the pictures, markings and symbols used. Any reproduction or disclosure, even partially, of the contents of this manual is strictly forbidden without prior written authorization of Sungrow.

The contents of the manual will be periodically updated or revised due to the product development. It is probably that there are changes of manual in the subsequent inverter edition. The latest manual can be acquired via visiting the web site at www.sungrowpower.com.

Symbols Explanation

Important instructions contained in this manual should be followed during

installation, operation and maintenance of the inverter. And they will be highlighted by the following symbols.

 **DANGER**

DANGER indicates a hazard with a high level of risk which, if not avoided, will result in death or serious injury.

 **WARNING**

WARNING indicates a hazard with a medium level of risk which, if not avoided, could result in death or serious injury.

 **CAUTION**

CAUTION indicates a hazard with a low level of risk which, if not avoided, could result in minor or moderate injury.

NOTICE







NOTICE indicates a situation which, if not avoided, could result in equipment or property damage.



NOTE indicates additional information, emphasized contents or tips to help you solve problems or save time.

Symbols on the Inverter Body

 **WARNING**

-  Disconnect the inverter from all the external power sources before service!
-   Do not touch live parts until 10 minutes after disconnection from the sources!
-  Hot surface! May exceed 60°C!
-  Danger to life due to high voltages! Only qualified personnel can open and service the product!
-  Check user manual before service!

Content

About This Manual	1
1 Safety Instructions.....	1
2 Product Description.....	6
2.1 Intended Usage	6
2.2 Product Introduction.....	7
2.2.1 Appearance	7
2.2.2 Dimensions.....	8
2.2.3 LCD Display.....	8
2.2.4 DC Switch	9
2.3 Technical Description.....	9
2.3.1 Circuit Diagram	9
2.3.2 Function Description	10
2.3.3 Derating.....	11
3 Installation Flow.....	13
4 Unpacking and Storage	15
4.1 Unpacking and Inspection	15
4.2 Identifying Inverter	15
4.3 Scope of Delivery	17
4.4 Inverter Storage.....	17
5 Mechanical Installation	19
5.1 Installation Site Selection	19
5.2 Moving Inverter to Installation Site.....	21
5.3 Installing the Inverter	22
5.3.1 Installing to Metal Frame	23
5.3.2 Installing to Concrete Wall.....	24
6 Electrical Connection.....	27
6.1 Terminal Description	27

6.2	AC Side Cable Connection.....	28
6.2.1	AC side requirements	28
6.2.2	Grid Connection	31
6.3	PV Array Connection.....	34
6.3.1	PV Input Configuration	35
6.3.2	PV Input Connection.....	36
6.4	Grounding the Inverter.....	39
6.4.1	Grounding System Overview.....	39
6.4.2	Second Protective Earth Terminal.....	40
6.5	Communication Connection	41
6.5.1	Communication Overview.....	41
6.5.2	RS485 Communication System.....	42
6.5.3	RS485 Communication Connection.....	45
6.5.4	Ethernet Connection	47
7	Commissioning	50
7.1	Inspection before Commissioning	50
7.2	Commissioning Procedure	50
8	Disconnecting, Dismantling and Disposing the Inverter	54
8.1	Disconnecting the Inverter	54
8.2	Dismantling the Inverter	55
8.3	Disposal of the Inverter	55
9	Troubleshooting and Maintenance	56
9.1	Troubleshooting.....	56
9.1.1	Troubleshooting of LED Indicator	56
9.1.2	Troubleshooting of Faults in LCD Screen	56
9.2	Maintenance.....	60
9.2.1	Routine Maintenance	60
9.2.2	Maintenance Instruction	61
9.3	Contact Sungrow Service.....	64
10	Operation of LCD Display	65
10.1	Description of Button Function.....	65

10.2	Menu Tree	66
10.3	Main Screen	67
10.4	Contrast Adjustment	68
10.5	Checking Running Information	68
10.6	Checking History Information	70
	10.6.1 Checking Running Records.....	70
	10.6.2 Checking Fault Records.....	70
	10.6.3 Checking History Event Records.....	71
	10.6.4 Checking Energy Records.....	71
10.7	Starting/Stopping.....	72
10.8	Password Entry	73
10.9	System Parameter Setting	73
	10.9.1 Language Setting	73
	10.9.2 Time Setting.....	74
	10.9.3 Total Energy Deviation Adjustment.....	74
	10.9.4 Load Default	75
	10.9.5 Checking Firmware Version	75
10.10	Running Parameter Setting.....	76
	10.10.1 Main Screen of Run-param	76
	10.10.2 Active/Reactive Power Parameters.....	77
	10.10.3 Reactive Power Regulation.....	78
	10.10.4 Reactive Power Setting for Italy.....	81
	10.10.5 Save P/Q-set	83
	10.10.6 Time Parameters	83
	10.10.7 LVRT Parameter	84
	10.10.8 Derating Parameters	84
	10.10.9 ISO Parameters.....	84
10.11	Protection Parameter Setting.....	85
	10.11.1 Country Setting.....	85
	10.11.2 Single-stage Protection Parameter Setting.....	87
	10.11.3 Multi-stage Protection Parameter Setting.....	87
	10.11.4 Protection Recovery Setting	88

10.11.5 Protection Parameter Confirmation.....	88
10.12 Communication Parameter Setting	88
10.13 Advanced Parameters Setting.....	89
10.13.1 PVS Detect Settings.....	89
10.13.2 10min Max-V	90
10.13.3 Grid Unbalance	91
11 Appendix	92
11.1 Technical Data.....	92
11.2 Exclusion of Liability	93
11.3 About Us	94
11.4 Contact Information	95

1 Safety Instructions

The inverter has been designed and tested strictly according to the international safety regulations. As electrical and electronic equipment, safety instructions related to them must be complied with during installation, commissioning, operation and maintenance. Incorrect operation or work may result in damage to:

- The life and well-being of the operator or a third party
- The inverter and other properties that belong to the operator or a third party

Therefore, the following general safety instructions must be read and always kept in mind prior to any work. All detailed work-related safety warnings and notes will be specified at the critical points in corresponding chapter.

WARNING

All installations should be performed by technical personnel. They have:

- **received professional training;**
- **read through this manual and understood all related safety instructions;**
- **been familiar with electric system related safety instructions.**

Technical personnel mentioned above may perform the following work:

- Install the inverter onto the wall;
- Connect the inverter to the PV system;
- Connect other devices to the PV system;
- Commission the inverter;
- Operate and maintain the inverter.

Before Installation

NOTICE

The unit is thoroughly tested and strictly inspected before delivery. Damage may still occur during shipping.

If there is visible damage to the packaging or the inner contents, or if there is something missing, contact Sungrow or the forwarding company.

⚠ CAUTION

There is a risk of injury due to improperly handling the device!

- **Always follow the instructions in the manual when moving and positioning the inverter.**
- **Injuries, serious wounds, or bruise may follow if the device is improperly handled.**

During Installation**⚠ DANGER**

Make sure inverter is not electrically connected before installing the inverter.

⚠ CAUTION

System performance loss due to bad ventilation!

The equipment requires good quality ventilation during operation. Keep the unit upright and nothing covering the heatsink.

During Electrical**NOTICE**

All electrical connection must be in accordance with national and local standards.

The connection to the grid can be done only after receiving approval from the local utility grid company.

⚠ DANGER

Lethal voltage exists!

PV arrays will produce electrical energy when exposed to sunlight and thus can create potential electrical shock hazards.

⚠ WARNING

All cables must be firmly attached, undamaged, properly insulated and adequately dimensioned.

During Inverter Operation

DANGER

Do not disconnect inverter DC side connection while the inverter AC side is under load!

First, de-energize inverter from dual power sources and then verify that there is no voltage present.

WARNING

Do not open inverter enclosure when inverter is under load or operating.

Only intact and locked inverter cabinet can ensure personal and property safety.

CAUTION

There is a risk of burn!

Do not touch device hot parts (for example, the heatsink) during operation. Only the LCD display and DC switch can be touched during operation.

Operate the inverter by strictly following the descriptions in this manual to avoid unnecessary injury to the persons and damage to the device. Arc flash, fire or explosion may follow if otherwise and Sungrow will hold no liability for the damages followed.

WARNING

At least the following improper operations can cause the arc flash, fire and explosion inside the device. Remember all the time that these accidents can only be handled by qualified personnel. Improper handling of the accidents occurred may lead to more serious fault or accident.

- **Plug and unplug the DC side HV fuse when it is alive;**
- **Touch the end of the cables that has no insulating treatment and may still be alive;**
- **Touch the connection copper bus bar, terminal or other spare parts inside the device that may be alive;**
- **The power cable connection is loose;**
- **Spare parts like the bolts are falling inside the inverter;**
- **Incorrect operation of the non-qualified persons that receives no training;**

 **WARNING**

Before any operation to the device, a beforehand assessment of the possible arc flash in the operation area is necessary. If there is arc flash,

- **The operators must receive related safety trainings;**
- **Try the best to assess the areas that may appear the electric shock;**
- **Before any operation in the area that may appear electric shock, wear personal protective equipment (PPE) that meets the requirement. A PPE category 2 is recommended.**

Maintenance and Service

 **DANGER**

There is a risk of inverter damage or personal injury due to incorrect service work!

Before any operation, you should perform the following steps:

- **First disconnect the grid side switch and then disconnect the DC switch;**
- **Wait at least 10 minutes until the inner capacitors are discharged completely;**
- **Verify, using proper testing device to make sure there is no voltage or current.**

 **CAUTION**

Keep unrelated person away!

A temporary warning sign and barrier must be posted to keep non-related person away during electrical connection and maintenance.

NOTICE

- **Restart the inverter only when the fault that may impair the inverter safety functions is removed.**
- **Inverter contains no owner serviceable part inside. Please contact local authorized personnel if any service work is required.**

NOTICE

Do not replace the inverter internal components without permission. Damages may follow and it may void any or all warranty rights from Sungrow.

NOTICE

There is a risk of inverter damage due to electrostatic discharge!

The printed circuit boards contain components sensitive to electrostatic discharge.

- **Wear a grounding wrist band when handling the boards.**
- **Avoid unnecessary touch with the boards.**

Others

NOTICE

Certain parameter setting (country selection, etc.) on the LCD display must only be done by professional persons.

Incorrect country setting may affect the inverter normal operation and cause a breach of the type-certificate marking.

WARNING

All safety instructions, warning labels nameplate on the inverter:

- **Must be clearly visible;**
- **Should not be removed or covered.**

WARNING

Respect the following regulations:

- **Grid-connection regulations;**
- **Safety instructions related to PV arrays;**
- **Safety instructions related to other electrical devices.**

2 Product Description

2.1 Intended Usage

SG60KTL inverter, 3-phase string inverter without transformer, is a crucial unit in the PV power system.

Inverter is designed to convert the direct current power generated from the PV modules into grid-compatible AC current and feeds the AC current to the utility grid. The intended usage of the inverter is illustrated in Fig. 2-1.

WARNING

Inverter cannot connect the PV strings whose positive and negative terminals need to be grounded.

Do not connect any local load between the inverter and the AC circuit breaker.

Inverter is applicable only to the grid-connected PV system. Any other usage is strictly forbidden.

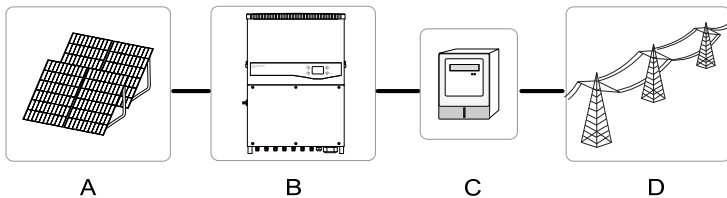
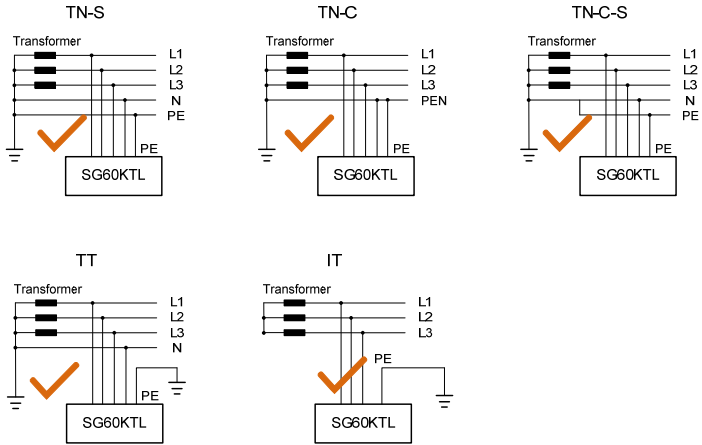

Fig. 2-1 Inverter application in PV power system

Item	Description	Note
A	PV strings	Monocrystalline silicon; polycrystalline silicon and thin-film without grounding
B	Inverter	SG60KTL
C	Metering device	Measure inverter output energy
D	Utility grid	TT, TN-C, TN-S, TN-C-S, IT

The following figure shows the common grid configurations.



More than one inverter can be connected to the system if the capacity of the PV system exceeds the capacity of a single inverter. Connect proper PV input for each inverter at the input side and connect the output side to the grid.

2.2 Product Introduction

2.2.1 Appearance

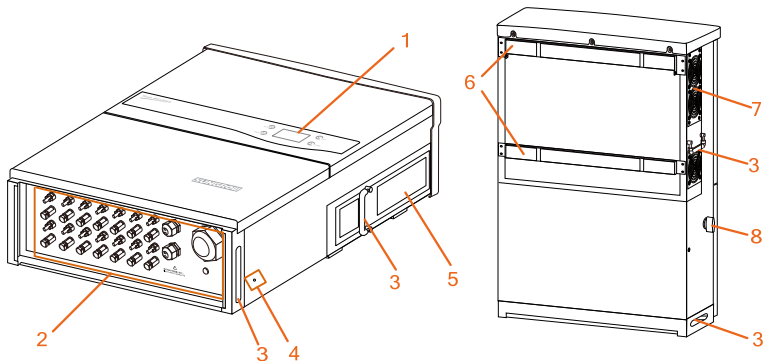

Fig. 2-2 Appearance

* Pictures are indicative only. Product in kind prevail.

No.	Name	Description
1	LCD display	Human-computer interface for viewing of the running information and parameter configuration.
2	Electrical connection area	Include DC terminal, AC terminal and RS485 communication terminal.
3	Handles	Handles are designed for transporting, installing and disassembling the inverter
4	PE second terminal	Specified in EN 50178, user can connect this terminal as per requirements.
5	Air outlet	Controlled forced-air cooling method. Ensure well ventilation.
6	Hanger	Hang the inverter to the backplate.
7	Fans	3 fans used for inverter forced cooling
8	DC switch	Protective components to safely disconnect DC side current.

2.2.2 Dimensions

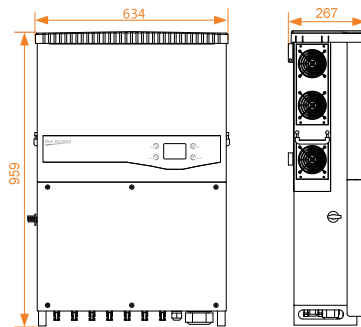

Fig. 2-3 Dimensions of the inverter (in mm)

2.2.3 LCD Display

As a human-computer interaction interface, LCD display comprises two LED indicators and two buttons for user to check the inverter operation information and configure inverter parameters.

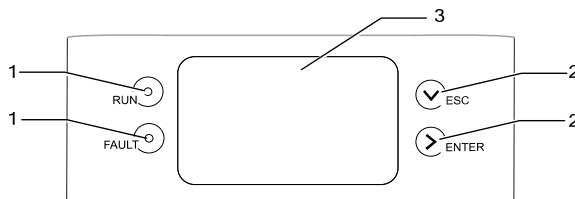

Fig. 2-4 LCD display

Tab. 2-1 Description of LCD display

No.	Name	Description
1	LED indicators	"RUN" and FAULT". Indicate the inverter operation state. Detailed explanation is shown in Tab. 2-2
2	Buttons	Two buttons for LCD operation and parameter configuration. Detailed explanation is shown in 0
3	LCD screen	Display inverter present state, operation information, history information and parameters, etc.

Tab. 2-2 Description of LED indicators

LED state	Description
"RUN": ON "FAULT": OFF	Inverter is running.
"RUN": OFF "FAULT": ON	A fault occurs, or protection function is enabled.
"RUN" : OFF "FAULT": OFF	Inverter does not operate, or communication fault occurs between the DSP and LCD display.
"RUN": Flicker "FAULT": OFF	Warning information occurs to the inverter.

2.2.4 DC Switch

DC switch is used to disconnect the DC current safely whenever necessary.

Inverter operates automatically when input and output requirements are met. Turn the DC switch to the OFF position to stop the inverter when a fault occurs or when you need to stop the inverter.



Turn the DC switch to the ON position before restart the inverter.

2.3 Technical Description

2.3.1 Circuit Diagram

Fig. 2-5 shows the main circuit of the inverter.

MPPT is utilized for DC input to ensure the maximum power from the PV array at different PV input conditions.

Inversion circuit converts the DC power into AC power and feeds the AC power to the utility grid through the AC terminal. The protection circuit is equipped to ensure the device safe operation and personal safety.

DC switch is used to disconnect the DC current safely; inverter provides standard RS485 ports for communication. User can check running data and set related parameter through the LCD display.

Inversion circuit

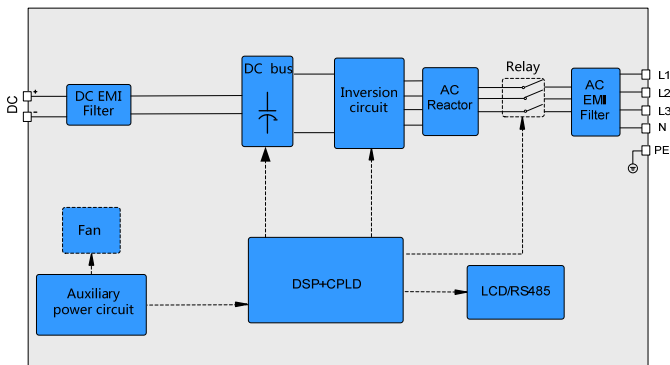

Junction box

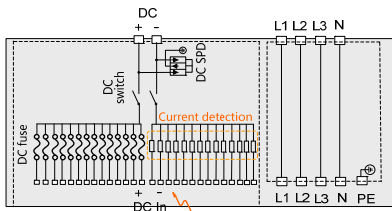

Fig. 2-5 Circuit diagram of SG60KTL

2.3.2 Function Description

- Inversion function
Inverter converts the DC current into grid-compatible AC current and feeds the AC current into grid.
- Data storage and display
Inverter achieves the running information, fault records and etc. and displays them on the integrated LCD display.
- Parameter Configuration
Inverter provides various parameter configuration for inverter optimal operation.

- **Communication Interface**
Standard RS485 port, can be connected to monitoring device and PV system
- **Protection Function**
 - Short-circuit protection
 - Ground insulation resistance detection
 - Inverter output voltage monitoring
 - Inverter output frequency detection
 - Residual current protection
 - DC injection of AC output current surveillance
 - Anti-islanding protection
 - Ambient temperature monitoring
 - DC over-voltage protection
 - Over-current protection
 - Power module over-temperature protection

2.3.3 Derating

Output derating is a way to protect the inverter from overload or potential faults. Situations require inverter power derating are:

- Internal temperature is too high (including ambient temperature and module temperature)
- Grid voltage is too low
- External power class adjustment
- Grid frequency is too high^[*]

Note: [*] valid only when the country selected is DE or IT.

Power Limit Setting

Inverter output power can be adjusted via the LCD display or remote grid dispatch from the grid company. The corresponding operating state will display on the LCD screen.

Over-temperature Derating

High ambient temperature, fan broken or poor ventilation will lead to inverter power derating.

- When the module temperature exceeds the upper limit, inverter will derate power output until the temperature drops within the permissible range.

- When the internal temperature exceeds the upper limit, inverter will derate power output until the temperature drops within the permissible range.

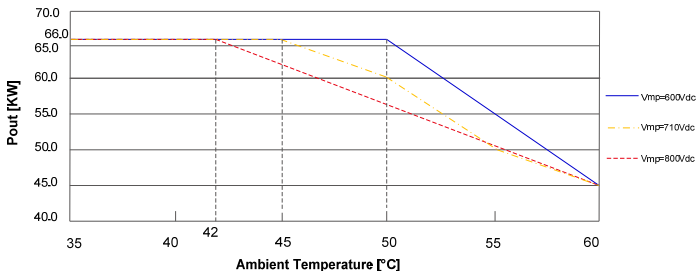

Lower limit of the over-temperature derating: 75% of the nominal power.



If the module temperature and internal temperature reach to power derating conditions, inverter will derate the power output according to the lower temperature between the two.

Grid Under-voltage Derating

When grid voltage is low, inverter will derate the output power to make sure the output current is within the permissible range. Once the grid voltage is within $V_{min} \dots 215V$, inverter will derate the output power.

$$P_{[V_{min} \dots 266V]} = P_n \times (V_{grid} / 230V)$$

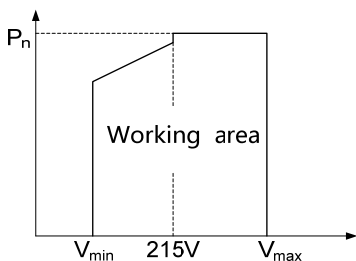

Fig. 2-6 Grid under-voltage derating

3 Installation Flow

Fig. 3-1 shows the installation flow of the inverter and Tab. 3-1 gives the detailed explanation.

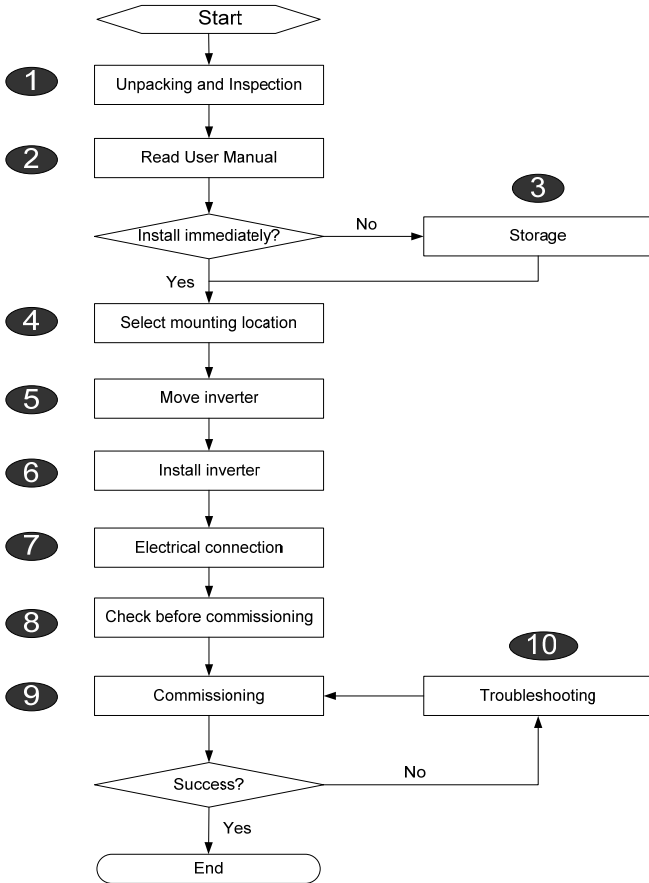

Fig. 3-1 Installation flow

Tab. 3-1 Description of installation flow

Step	Description	Reference
1	Unpacking and inspection	4.1
2	Read the User Manual, especially the section on "Safety Instruction"	1
3	Store the inverter if it is not to be installed immediately	4.4
4	Select optimal installation site	5.1
5	Move the inverter to the installation site	5.2
6	Install the inverter to the selected installation site	5.3
7	Electrical connection; DC side connection; AC side connection; Ground connection; Communication connection.	6.3~6.7
8	Inspection before commissioning	7.1
9	Start up the inverter and configure corresponding parameters.	7.2
10	Troubleshooting	9.1

4 Unpacking and Storage

4.1 Unpacking and Inspection

Although being strictly tested and checked, damages may still occur to the inverter during shipping. Therefore, the first thing you should do after receiving the device is to conduct a thorough inspection.

- Check the packing for any visible damage upon receiving.
- Check the completeness of delivery contents according to the packing list.
- Check the inner contents for damage after unpacking.

If any damage is found, please contact Sungrow or the forwarding company.

Do not disposal of the original packaging. It is best to store the inverter in its original packaging.

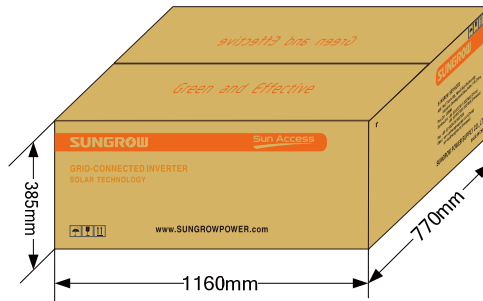

Fig. 4-1 Inverter paper packaging

4.2 Identifying Inverter

The nameplate is attached to one side of the inverter and the packaging carton respectively. It provides information on type of inverter, important specifications, marks of certification institutions, and serial number which is available and identified by Sungrow.

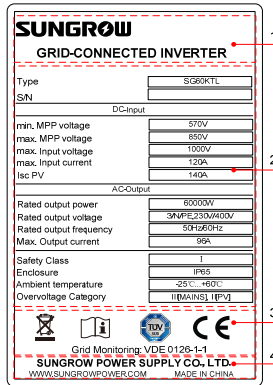

Fig. 4-2 Inverter nameplate

*Image shown here is indicative only. Product in kind prevail.

Item	Description
1	SUNGROW logo and product type
2	Inverter technical data
3	Marks of certification institutions
4	Company name, website and origin

Tab. 4-1 Description of icons on the nameplate

icon	Description
	Do not dispose of the inverter with household garbage.
	Refer to corresponding instructions.
	TUV mark of conformity. The inverter is in compliance with directives of TUV.
	CE mark of conformity. The inverter is in compliance with directives of CE.

4.3 Scope of Delivery

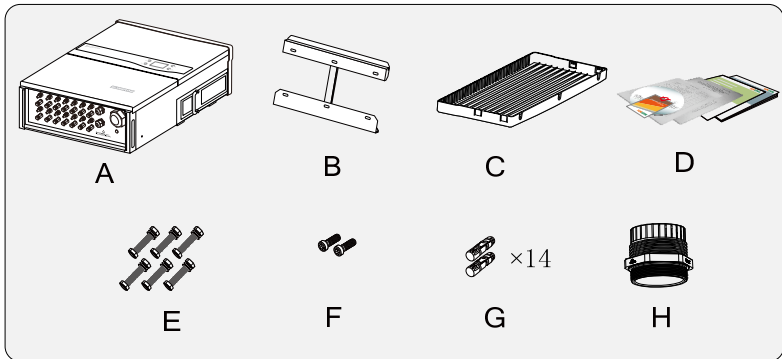

Fig. 4-3 Scope of delivery

Item	Name	Description
A	Inverter	---
B	Backplate	Used to fix the inverter to the installation site.
C	Inverter cap	For better weather-proof function of the inverter.
D	Documents	Quality certificate, packing list, product test report, CD and quick user manual
E	Fasten set	Six units to fasten backplate to metal frame.
F	Fix screw	Two M4×16 screws to fix the inverter with the backplate.
G	DC connector	Fourteen pairs MC4 terminals for PV connection.
H	AC cable gland	When the external diameter of the AC cable you selected matches it, replace the original AC cable gland on the bottom of the device before wiring.

4.4 Inverter Storage

Store the inverter properly when the inverter is not to be installed immediately. Sungrow shall hold no liability for the corrosion of the device or the failure of device internal components caused by storage of the device not following the requirements specified in this manual. Inverter must be packed into its original carton with the desiccant bags inside.

- Inverter must be packed into its original carton with the desiccant bags inside.
- Seal the packing carton with adhesive tape.
- Store the inverter in a dry and clean place to protect it against dust and moisture.

- Relative temperature: $-30^{\circ}\text{C}\dots 85^{\circ}\text{C}$; Relative humidity: 0-100%.
- If one inverter is stacked on top of the other inverter, the max. stack layer should be two.
- Keep distance from the chemical corrosive materials to avoid possible corrosion.
- Periodically (recommended: six months) check for any visible damages during the storage period. Replace the packing in time if necessary.
- The packing should be upright.

5 Mechanical Installation

5.1 Installation Site Selection

Select an optimal installation site for install safe operation, long service life and outstanding performance.

- Take the load capacity of the wall into account. The wall (concrete wall or metal frame) should be strong enough for the weight of the inverter over a long period.
- Install the inverter where is convenient for electrical connection, operation and maintenance.
- Do not install the inverter on the wall made up of flammable materials.

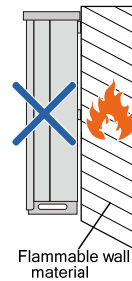

- Do not install the inverter near flammable materials or gas.

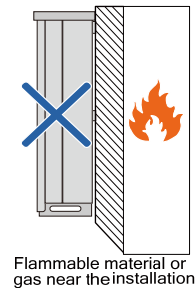

- Install the inverter at eye-level for easy button operation and display read.

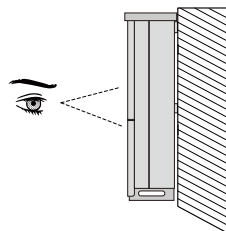

- Do not install the inverter upside down or with an inclination.

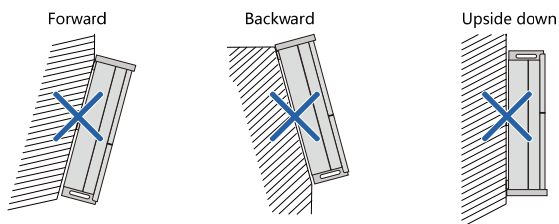

- With an IP65 protection rating, the inverter can be installed both outdoors and indoors.
- The ambient temperature should be within -25°C to 60°C . Inverter will operate with power derating if temperature is too high.
- The relative humidity range of the installation site is 0-100%.



Max. ambient temperature: **+60°C**



Min. ambient temperature: **-25°C**



Relative humidity: **0-100%**

- Do not expose the inverter to direct sunlight or rain or snow. Shaded installation site is preferred.

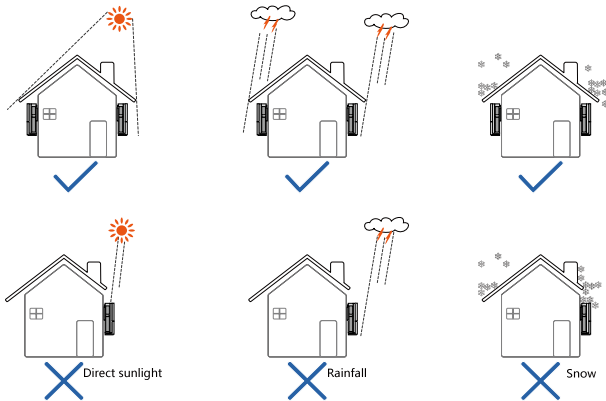

- Take enough space for convection into consideration when installing multiple inverters. It is suggest to stagers the inverters.

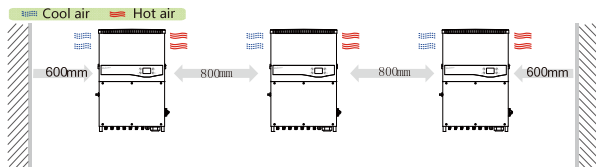

- Do not install the inverter in a confined space. Inverter will not work normally if otherwise.
- Install the inverter where children cannot reach.
- Do not install the inverter near residential area. Noise can be produced during inverter operation which may affect the daily life.

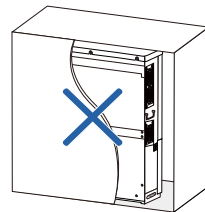

5.2 Moving Inverter to Installation Site

To install the inverter, remove the inverter from the packaging and move it to the installation site. Follow the instructions below during inverter moving:

- Always keep in mind the weight of the inverter.
- Lift the inverter by gasping the handles on two sides of the inverter.

- Move the inverter by two persons or proper moving devices.
- Do not release the equipment unless it has been secured to the wall firmly.

5.3 Installing the Inverter

Inverter is installed to the wall by the backplate enclosed in the packing. If you do not use the supplied backplate, you can drill holes as per specifications below:

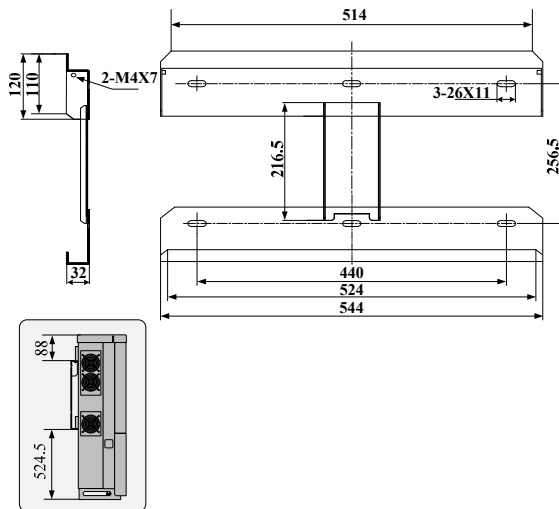

Fig. 5-1 Dimensions of the backplate (figures in mm)

The stainless fasteners are supplied for attaching the backplate to metal frame.

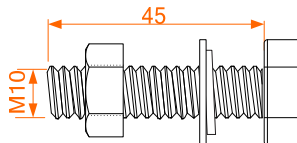

Fig. 5-2 Dimensions of fastener for metal frame (figures in mm)



To install the inverter to concrete walls, user needs to purchase expansion bolts with proper size (recommended: M10*65) to fix the backplate to the concrete walls.

5.3.1 Installing to Metal Frame

- Step 1** Remove the backplate and fasteners from the packaging.
- Step 2** Place the backplate to the chosen metal frame and adjust it to proper position and height.
- Step 3** Mark the position for holes drilling according to the holes position of the backplate.
- Step 4** Drill holes according to the marks make before. If the shape of the metal frame does not match the backplate, re-drill holes on the backplate according to the metal frame chooden.

Mark positions

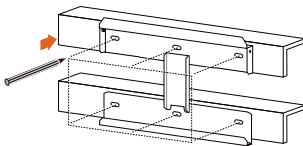

Drill holes

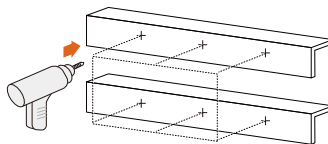

- Step 5** Secure the backplate to the metal frame firmly by the supplied fastener. Torque of the fasten nut is 35 N•m.

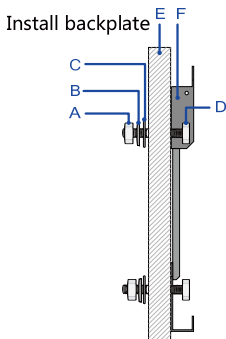

No.	Name	Description
A	Hexagon nut	M10
B	Spring washer	-
C	Flat washer	-
D	Screw bolt	M10*45
E	Metal frame	-
F	Backplate	-

- Step 6** Lift the inverter above the backplate and then slide down to make sure they match perfectly.
- Step 7** After putting the inverter on the backplate, secure the inverter to the backplate with two M4×16 screws (fix screw hole has its own nut).
- Step 8** Install the inverter cap.

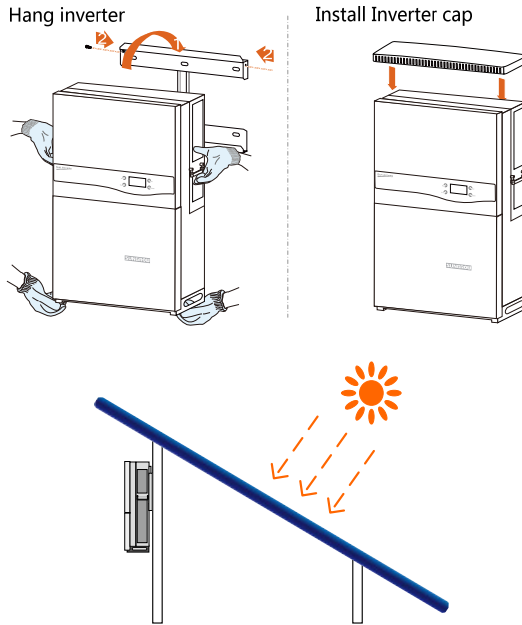

5.3.2 Installing to Concrete Wall

- Step 1** Remove the backplate and corresponding fasteners from the packaging.
- Step 2** Place the backplate to the chosen concrete wall and adjust it to proper position and height.
- Step 3** Mark the position for holes drilling according to the holes position of the backplate.
- Step 4** Drill holes according to the marks make before.

DANGER

Check to ensure that there is no other electronic or plumbing installation inside the wall before drilling holes.

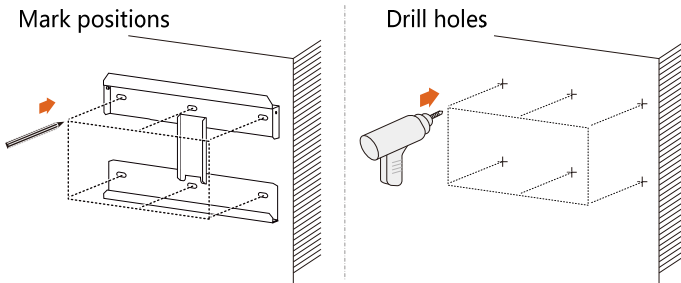

Step 5 Secure the backplate to the wall firmly by the supplied expansion bolt sets. Torque of the fastener is 35 N·m.

Install backplate

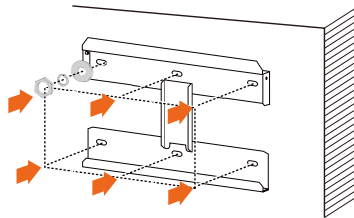

- If the installation location is lower, the inverter can be directly linked to the backplate, please follow step 6 and then jump to Step 10.
- If the installation location is higher, the inverter can not be directly linked to the backplate, please perform steps 7 to 11.

Step 6 Lift up inverter above the backplate and then slide down to make sure that the recesses on the back of the inverter fit perfectly together with the backplate.

Step 7 Screw two M12-screwed lifting rings to the screw holes on top of the inverter.

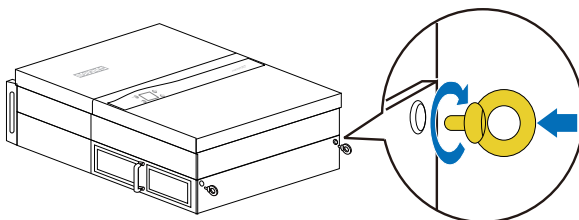



M12-screwed lifting ring is a standard component. It is not within the scope of delivery. Please purchase from the market if needed.

- Step 8** Lead the rope (with sufficient load-carrying capacity) prepared beforehand through the two lifting rings to lift the inverter. Inverter is lifted to the level of the fixed backplate or adjacent place.

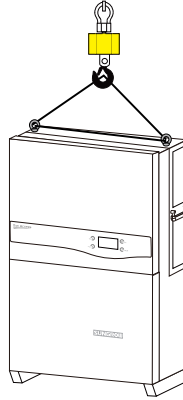

NOTICE

Please keep the inverter balance during the whole process of inverter lifting. Inverter may hit the wall or other obstacles if otherwise.

- Step 9** Fit the inverter to the backplate, refer to step 6.

- Step 10** After fit the inverter to the backplate, fasten the inverter to the backplate with two M4×16 screws.

- Step 11** Assemble the cap onto the inverter for better weatherproof function.

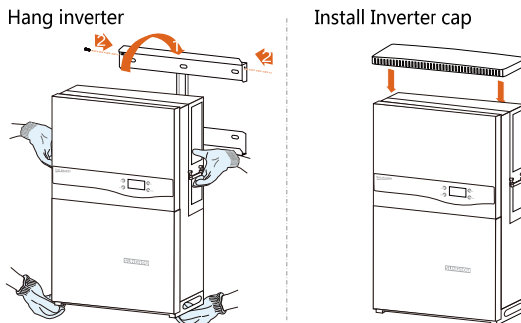

6 Electrical Connection

Once the inverter is secured to the installation site, it can be connected to the PV system.

All electrical connection must comply with local regulations and related electrical rules (AS 4777.1 etc.).

WARNING

- **Improper cable connection may lead to fatal personal injury or device permanent damages.**
- **Cable connection can be done only by professional personnel.**
- **Always keep in mind that the inverter is dual power supplied. Electrical operators must wear proper personal protective equipment: helmet, insulated footwear and glove, etc.**

6.1 Terminal Description

Inverter electrical connection terminals and cable entries are all at the inverter junction box as shown in Fig. 6-1.

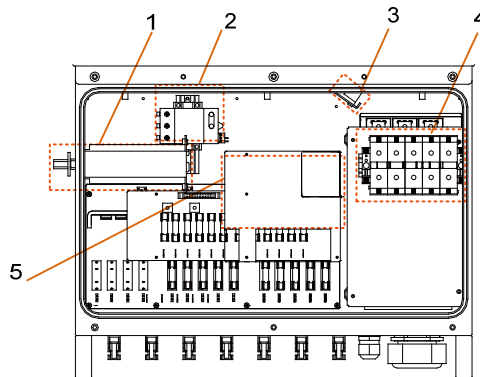

Front view

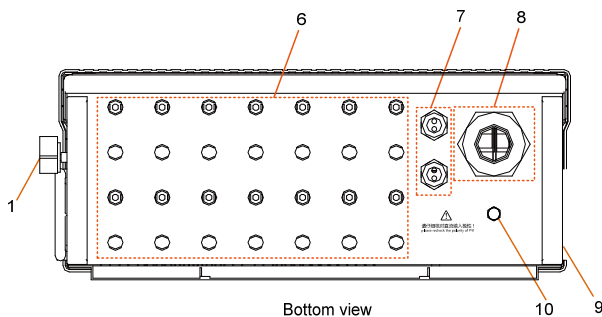

Fig. 6-1 Cable connection area

*Pictures are indicative only. Please in kind prevail.

No.	Description	No.	Description
1	DC switch	6	DC input plug-in terminal
2	DC SPD	7	Communication cable glands
3	Cooling fan	8	AC cable gland
4	AC crimping terminal	9	Second PE terminal
5	Configuration circuit board	10	Waterproof air valve

6.2 AC Side Cable Connection

6.2.1 AC side requirements



Connection to the utility grid must be done only after receiving approval from the local company.

Before grid-connection, verify to make sure the grid voltage and frequency meet the requirements of the inverter. Contact the local grid company for solution if otherwise. For detailed parameter, please refer to 11.1 Technical Data.

AC Circuit Breaker

An independent three or four-pole circuit breaker is installed outside the output side of the inverter to ensure that the inverter can be disconnected safely.

Inverter	Recommended AC circuit breaker
SG60KTL	120A

NOTICE

- It is not allowed for several inverters to use one circuit breaker.
- It is not allowed to connect loads between inverter and circuit breaker.

Residual Current Device

With an integrated comprehensive residual current monitoring unit inside, the inverter is able to distinguish the fault current from normal capacitive leakage current. Inverter will disconnect from the grid as soon as a fault current of more than limit value is detected.

Multiple Inverters in parallel Connection

The following different requirements must be respected if several inverters are in parallel connection to the grid.

If an external RCD or residual current breaker is installed, the switch should be triggered when the fault current is 600mA or higher.

Scenario 1:

Several inverters are in parallel connection to the 3-phase low voltage grid

Requirements:

If the number of the grid-connected inverters exceed 40, please contact Sungrow.

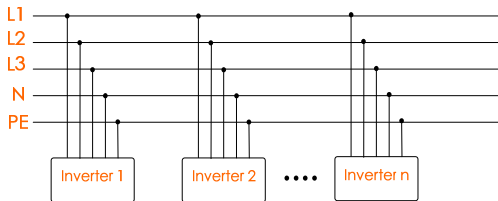
**Scenario 2:**

Several inverters are in parallel connection to the low voltage side of the MV transformer. The high voltage side is connected to the middle voltage grid.

Requirements:

If the number of the grid-connected inverters exceed 40, please contact Sungrow.

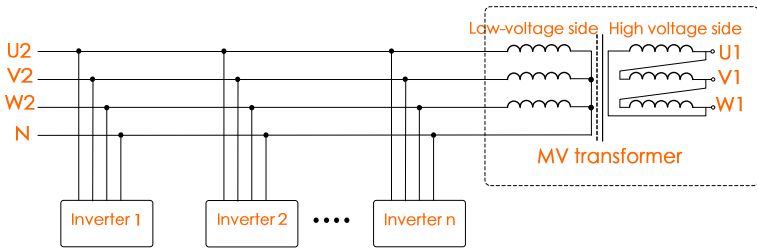

Medium-voltage Transformers

The following requirements must be observed when installing medium-voltage transformers:

- The transformer for the inverter can be a distribution transformer, however it must be designed for the typical cyclical loads of a PV system (load in the day and possibly no load at night).
- The transformer can be of the liquid-immersed type or dry type. Shield winding is not necessary.
- The line-to-line voltage on the low-voltage side of the transformer must endure the output voltage of inverter. When connecting to the IT grid, the withstanding voltage of the low-voltage winding side of the transformer, the AC cables and the secondary devices (including the relay protection, detection & measuring, and other related auxiliary devices) to the ground should not be lower than 1000V.
- The line-to-line voltage on the high-voltage side of medium-voltage transformer should comply with the power grid voltage of installation site.
- A transformer with a tap changer on the high-voltage side is recommended in order to remain consistent with the grid voltage.
- At an ambient temperature of 25°C, transformers should withstand 110% of total load rating.
- Transformer with a short-circuit impedance less than 6% is recommended.
- For thermal rating, the load curve of the transformer and the ambient conditions at the respective installation site must be taken into account.
- The inverter apparent power is not permitted to exceed the transformer power. The maximum nominal AC current of all connected inverters must be taken into account. If the number of the grid-connected inverters exceed 40, please contact Sungrow.

- The transformer must be protected from overloading and short circuiting.
- The transformer is an important part of grid-connected PV generation system. The fault carrying capacity of the transformer should be taken into account at all times. The fault types include: system short-circuit, grounding fault, voltage drop, and etc...
- Ambient temperature, relative humidity, altitude, air quality, and the relevant indexes should be taken into account at all times.
- The country-specific power grid frequency should be taken into account at all times.
- The country-specific standards and directives should be taken into account at all times.

6.2.2 Grid Connection

AC terminal block is on the bottom of the inverter. AC connection is the 3-phase-5-wire grid connection (L1, L2, L3, N and PE).

AC Cable Requirements

Select AC cables according to the following factors:

- Grid impedance corresponds to the specifications below to avoid accidental short-circuit or output power derating.

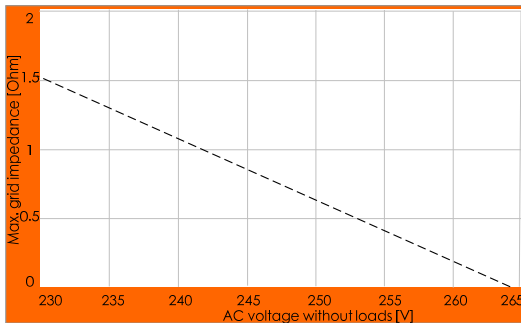

- Considering the voltage drop and other conditions, please enlarge the cable dimension. Power loss of the cable should be less than 1% of the nominal power.
- Withstand ambient temperature.
- Cable layout (inside wall, underground, free air, etc.)
- UV resistance and so on.

Connecting Inverter to Grid

⚠ DANGER

High voltage inside the inverter!

Ensure all cables are voltage-free before electrical connection.

Do not connect the AC circuit breaker until all inverter electrical connections are completed.

Step 1 Disconnect the AC circuit breaker and ensure it will not reconnect accidentally.

Step 2 Unscrew the 6 bolts on the front cover of the lower junction box.

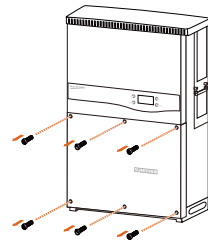

Step 3 Peel the cables as shown below.



For flexible cables (stranded wires), use cold pressing terminal lugs.

The cross-section of the AC cable must be selected carefully in order to prevent accidentally disconnections of the inverter from the grid due to high impedance of the cable.

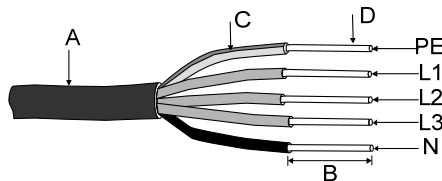

No.	Description	Remark
A*	Protective layer	External diameter of the cable: 25~40 mm
B	Length of insulation to be stripped off	24 mm
C	Insulation layer	-
D	Cross section of AC cables	Range: 25-95mm ² ; recommended value: 50 mm ²

* The external diameter of the AC cable described in A is proper range.

- If you select AC cable with the external diameter within the range of 25~30.5 mm, please select the smaller AC cable gland.

- If you select AC cable with the external diameter within the range of 30.5~40 mm, please select the larger AC cable gland.

The following table gives the recommended max. length of the AC cables based on the cross-section of the AC cables.

Cross-section of the AC cable (mm ²)	Max. length of the AC cables (m)
25	0-50
35	50-100
50	>100

Step 4 Select the adaptive wire diameter of AC cable gland according to actual AC cable diameter. Remove or install the two AC cable glands on the bottom of the device by torque of recommended value.

- Remove or install the smaller AC cable gland by torque of 12...13 N·m.
- Remove or install the larger AC cable gland by torque of 16...17 N·m.



Peel the plastic film on one end of the AC cable protection with proper tools before AC cable connection. Only the AC cable protection itself needs to be replaced; other accessories (packing nuts) can still be used.

Step 5 Fix the AC cable to the corresponding terminals with torque of 8...12 N·m.

Step 6 Pull the cable gently to make sure it is secured.

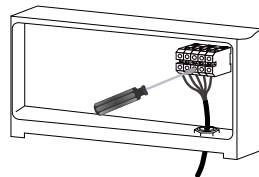

* Pictures here are indicatively only. Product in kind prevail.

If the cross-section of the AC cable is sectorial, please place the apex(A) of sector below and then fix the AC cable to the corresponding terminals..

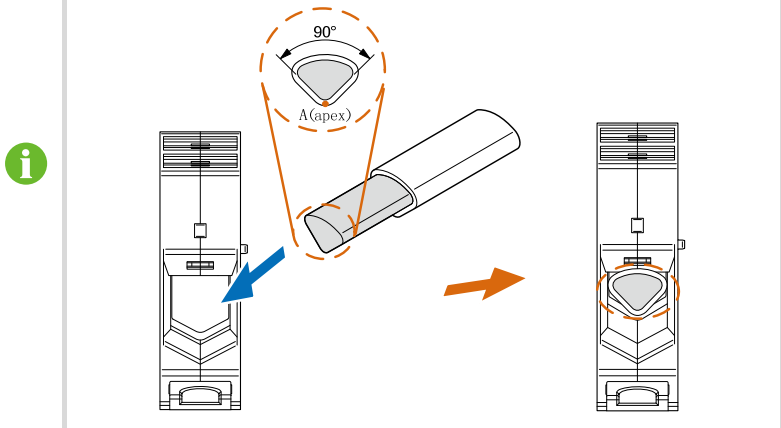

NOTICE

- **Observe the AC terminal layout. Device will not work normally if the phase cable is connected to the PE terminal.**
- **Do not squeeze or press the cable insulation layer. Improper connection may affect the normal operation of the inverter.**

Step 7 Seal the gaps between the AC cable and the gland inside the lower part of the cabinet by fireproofing mud.

6.3 PV Array Connection

DANGER

Lethal voltage exists!

PV arrays produce electrical energy when exposed to light and thus can create an electrical shock hazard.

DANGER

Make sure that the PV impedance to the ground is proper before connecting the PV array to the inverter.

6.3.1 PV Input Configuration

Inverter has a PV input area and a MPP tracker is equipped.

NOTICE

The following requirements must be respected. Ignorance of them may void any or all warranty rights.

- **The inverter internal cable connection cabinet is equipped with positive fuse and no negative fuse. During system design, configure or not configure the external fuse to the negative cables of the string according to the local regulations.**
- **Make sure the voltage of each PV array is less than 1000V at all times. Irrevocable damage may follow if otherwise.**
- **Make sure the max. short-circuit current of the DC side is within the permissible range. Irrevocable damage may follow if otherwise.**

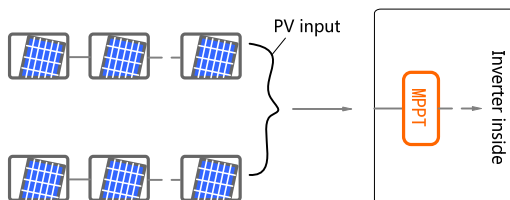

NOTICE

To make full use of the DC input power, the PV string should be with a homogenous structure: including the same type, the same number of PV cells, identical tilt and identical orientation.

Before connecting PV array to inverter, the following electrical parameters must be met.

Total DC power limit	Max. open-circuit voltage limit for each input	Short-circuit current limit
67500W	1000V	140A

Considering the negative voltage temperature coefficient of PV cells, more attention should be paid to the open-circuit voltage of PV strings when the ambient temperature is the lowest.

Take YL250P-29b PV cells for example.

Item	Parameter
PV cell type	YL250P-29b
Power	250W
Open-circuit voltage (STC)	37.6V
Short-circuit current (STC)	8.92A

Item	Parameter
Open-circuit voltage temperature coefficient (β)	-0.32%/°C
No. of PV cells in a PV string	23

Under the STC condition, where ambient temperature is 25°C, the open-circuit voltage of PV cells is $37.6V \times 23 = 864.8V < 1000V$.

Supposed that the lowest temperature is -25°C, the open-circuit voltage of PV cells is $23 \times 37.6V \times [1 + \beta \times (\text{min. ambient temperature} - \text{STC temperature})] = 23 \times 37.6V \times [1 + (-0.32\%/^{\circ}\text{C}) \times (-25^{\circ}\text{C} - 25^{\circ}\text{C})] = 990V < 1000V$ (meet the operation requirement).

Therefore, PV string should be designed to meet the open-circuit voltage requirement even under the lowest ambient temperature condition.

6.3.2 PV Input Connection

DC input should be connected using PV input terminal, which is within the scope of delivery.

PV string side cables should be equipped with DC connector and MC4 connector is within the scope of delivery.



To maintain the IP65 protection rate, only the supplied DC connector or connector with the same protection rate can be used.

DC Cable Requirements

Tab. 6-1 DC cable requirements

Cross-sectional area	Cable External diameter	Max. withstand voltage	Max. input current for each PV string
4~6mm ² 12AWG~10AWG	6~9mm	1000V	12A

NOTICE

The current of each DC input should be less than 12A; otherwise the fuse may blow out.

DC Cable Connection

⚠ DANGER

High voltage inside the inverter!

Make sure all DC and AC cables connected to the inverter are voltage-free before electrical connection.

Do not connect the AC circuit breaker before electrical connection is completed.

Step 1 Strip off 7mm insulation layer from all DC cables.

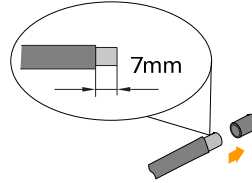

Step 2 Assemble cable ends with crimp contacts by crimping pliers.

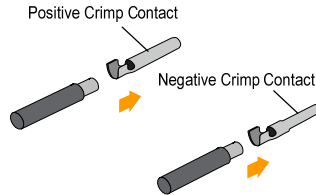

Step 3 Lead the cable through the cable gland.

Step 4 Insert the crimp contact into the insulator until it snaps into place. Then pull gently to make sure it is secured.

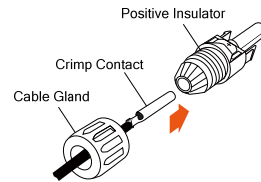

Step 5 Screw the cable gland to insulator with tightening torque 2.5...3 N·m.

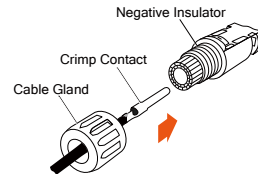

For more assembly and connection instruction, please visit the webpage of the device manufacturer.

Step 6 Check to make sure the polarities of PV strings are correct.

NOTICE

The inverter will not function properly if the DC polarities are reversed.

Step 7 Disconnect the DC switch.

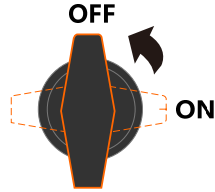

Step 8 Check the connection cable of PV string for the correct polarity and that the open-circuit voltage does not exceed the inverter input limit 1000V, even under the lowest operating temperature.

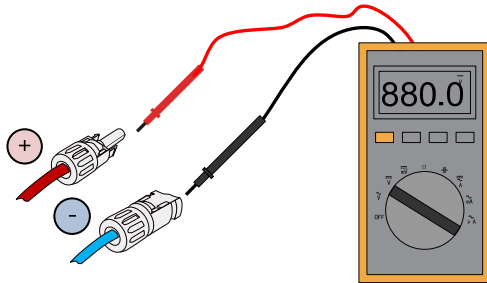

NOTICE

- **Check the positive and negative polarity of the PV cells. After confirmation, you can insert the DC connectors into the input terminals on the bottom of the inverter.**
- **For the same MPPT, reverse connection of a single string is prohibited. A permanent failure of the system or inverter may follow if otherwise.**

Step 9 Insert the positive and negative DC connectors into the input terminals on the bottom of the inverter until there is an audible sound.

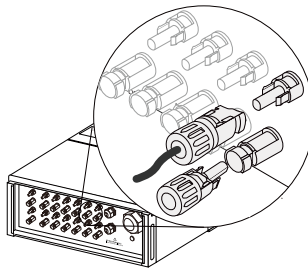

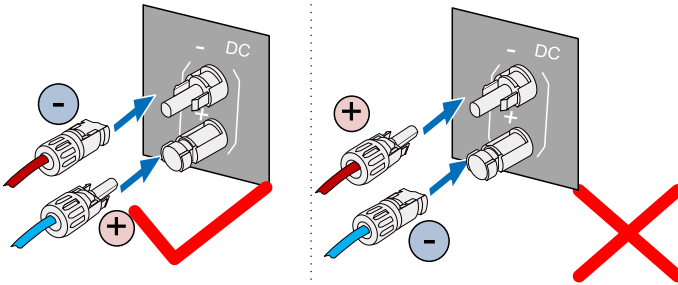

Step 10 Connect other PV strings following the above-mentioned procedures.

Step 11 Seal the unused DC terminals with waterproof plugs.

6.4 Grounding the Inverter

WARNING

Due to the transformer-less design of the inverter, neither the DC positive pole nor the DC negative pole of the PV string can be grounded.

6.4.1 Grounding System Overview

In this PV system, all non-current carrying metal parts and device enclosure should be grounded (such as the PV array frame and inverter enclosure).

When there is only one inverter in the PV system, ground the PE cable.

When there are multiple inverters in the PV system, they can be multi-point grounded. Connect PE cables of all inverters and the mounting metal frames of PV array to the equipotential cable (according to the on-site situation) to realize equipotential connection.

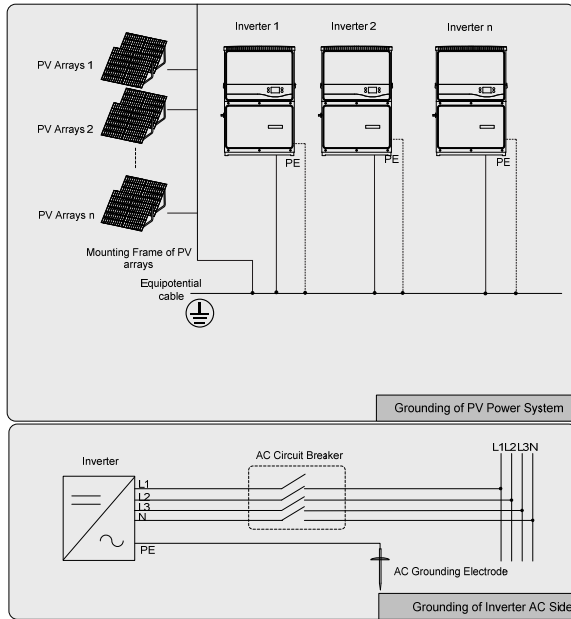

Fig. 6-2 Grounding of inverter

6.4.2 Second Protective Earth Terminal

Position of Second PE Terminals

There is a second PE terminal on one side of the inverter and it should be grounded.

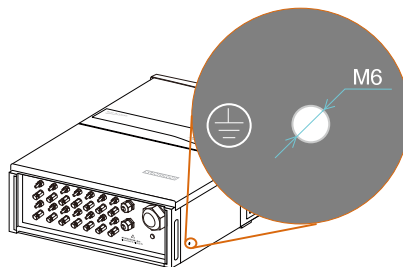

Fig. 6-3 Second PE terminal

⚠ WARNING

The ground connection of this second PE terminal cannot replace the connection of the PE terminal of the AC cables. Make sure the two PE terminals are all grounded reliably. Sungrow shall hold no liability for any possible consequences caused by ignorance of this warning.

Cable Connection

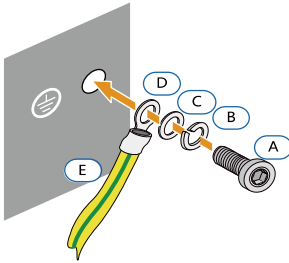

Fig. 6-4 Second PE connection

* Connection parts are not within the scope of delivery

Item	Name	Description
A	Screw	M6×12mm
B	Lock washer	-
C	Washer	-
D	Cable socket	-
E	Yellow-green cable*	-

*the cross-sectional area of the yellow-green cable shall be exactly the same with that of the PE cable of the AC cable.

6.5 Communication Connection

6.5.1 Communication Overview

There are two communication waterproof connection terminal on the bottom of the inverter. RS485 A/B terminals, RS485 interface and Ethernet interface (optional) are provided on the configuration circuit board of the junction box. A 120Ω terminating resistor can be connected between the A and B communication cable through the dip switch.

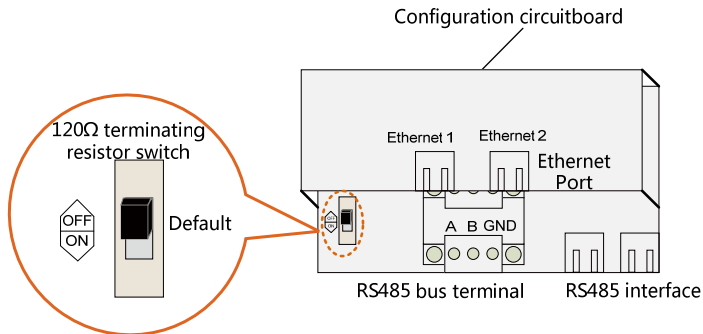

Fig. 6-5 Communication configuration

- Inverter operation information can be transferred to the PC of the installed monitoring software (e.g. SolarInfo Insight) or to a local data logging device (e.g. SolarInfo Logger) through RS485 communication connection.
- Inverter operation information can be transferred to the PC or router of the installed software (e.g. SolarInfo Insight) through Ethernet communication connection.

Prepare communication cable and RJ45 plug before communication connection.

NOTICE

RS485 communication cables should be:

- **Shielded twisted pair cables or Shielded twisted pair Ethernet cable.**



A converter such as RS485-232 converter or SolarInfo Logger is needed to convert signal between inverter and PC.

Network interface is an optional function. Contact Sungrow if necessary.

6.5.2 RS485 Communication System

For Single Inverter

Where there is only one inverter, a RS485 cable can guarantee the communication connection.

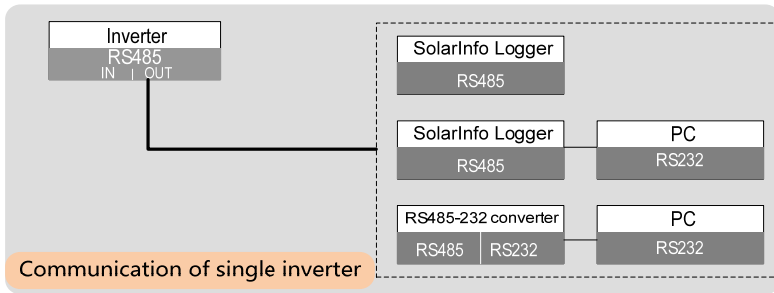

Inverter	Communication connection (RS485 bus connection or RS485-RJ45 connection)		Terminating Resistor
	RS485 bus	RJ45	
Single inverter	Only out 	Only out 	No

For Multiple Inverters

Where there is more than one inverter, all inverters can be communicated in a daisy chain through RS485 communication cable. The first and last inverters in the chain must be terminated with a resistor of 120Ω. The shielding layer of RS485 cable should be single-point grounded.



- The length of RS485 communication cable should be less than 1200m.
- If several inverters communicate with each other and connect to the SolarInfo Logger, at most 4 daisy chains are supported and 60 devices in total can be connected (i.e. 4 daisy chains can be connected with at most 15 devices connected to one chain or 3 daisy chains are connected with at most 20 devices connected to one chain).
- If several inverters communicate with each other and connect to the RS485-232 converter, at most 15 devices are allowed to connect to the daisy chain.

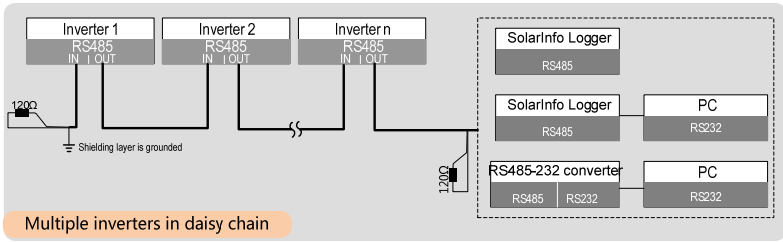

Inverter	Communication connection (RS485 bus connection or RS485-RJ45 connection)		Terminating Resistor	
	RS485 bus	RJ45	n ≤ 15	n > 15
Inverter 1	<p>Only out</p>	<p>Only out</p>	<p>No</p>	<p>Yes</p>
Inverter 2~n-1	<p>In and Out</p>	<p>In and Out</p>	<p>No</p>	<p>No</p>
Inverter n	<p>In and Out</p>	<p>In and Out</p>	<p>No</p>	<p>Yes</p>

6.5.3 RS485 Communication Connection

RS485A/B Bus Connection

- Step 1** Lead Network cable through communication cable gland to the configuration circuit board.
- Step 2** Strip off the insulation layer of the communication cable. Connect the A, B, and GND of RS485 communication cable to corresponding terminals according to the marks on the configuration circuit board.

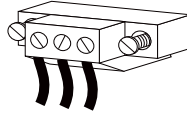

- Step 3** According to the position of the inverter (refer to the prior section), repeat step 1...2 to connect the other RS485 cables.
- Step 4** Pull cables outwards to confirm whether they are fastened firmly.
- Step 5** According to the position of the inverter (refer to the prior section), switch ON or OFF the terminating resistor.
- Step 6** Tighten the tread-lock sealing lock. Block off the vacant terminals to protect the dust and moisture penetrating inside the inverter.
- Step 7** Seal the gaps between the cable and the gland inside the lower part of the cabinet by fireproofing mud. If there is no other connection procedure, reassemble and fix the front cover of the connection cabinet.
- Step 8** Connect the communication devices. Refer to other manuals and documents if there are other devices.
- Step 9** Confirm the communication connection and set the communication parameters.



If more than one inverter is connected to PC or Logger, please set the communication parameters from the LCD display. For more information, please refer to 10.12 Communication Parameter Setting.

SolarInfo logger and RS485-232 converter are optional parts and can be ordered from Sungrow.

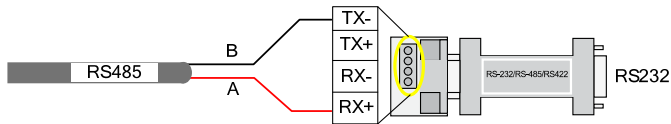

RJ45-RS485 Communication Connection

- Step 1** Lead Network cable through communication cable gland to the configuration circuit board.
- Step 2** Use the Ethernet crimper to crimp the cables and connect cables to RJ45 plug according to TIA/EIA 568B. In Ethernet cable, Pin 3 white-green cable defines RS485- B while Pin 6 green cable defines RS485+ A.

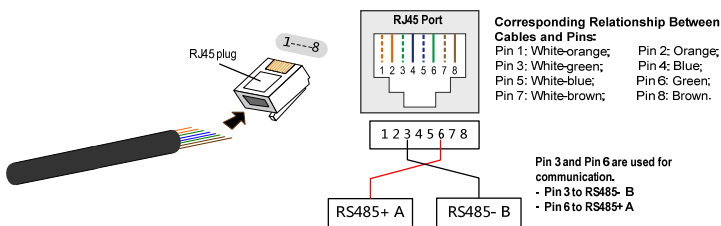

- Step 3** Connect the RJ45 plug into the RS485 in/RS485 out terminal on the configuration circuit board.
- Step 4** According to the position of the inverter (refer to the prior section), repeat step1...3 to connect the other RS485 cable to the RS485 out/RS485 in terminal.
- Step 5** Pull cables outwards to confirm whether they are fastened firmly.
- Step 6** Tighten the tread-lock sealing lock. Block off the vacant terminals to protect the inverter’s internal from dust and moisture.
- Step 7** According to the position of the inverter (refer to the prior section) switch ON or OFF the terminating resistor.
- Step 8** Seal the gaps between the cable and the gland inside the lower part of the cabinet by fireproofing mud. If there is no other connection procedure, reassemble and fix the front cover of the connection cabinet.
- Step 9** For the wires which connect to the logging devices, use the Ethernet wire stripper to strip the insulation layer and connect the RS485 A and B cables to data logging device or RS485-232 converter. Pin 3 white-green cable defines RS485- B while Pin 6 green cable defines RS485+ A.

Step 10 Refer to other manuals and documents if there are other devices.

Step 11 Confirm the communication connection and set the communication parameters.



If more than one inverter is connected to PC or Logger, please set the communication parameters from the LCD display. For more information, please refer to 10.12 Communication Parameter Setting.



SolarInfo logger and RS485-232 converter are optional parts and can be ordered from Sungrow.

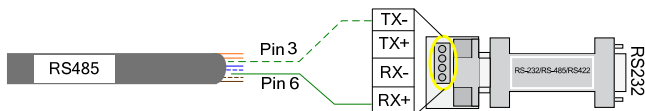

6.5.4 Ethernet Connection

Connect the inverter to PC through network ports to set up Ethernet communication.

Ethernet communication can be connected either in single, daisy chain or star topology.

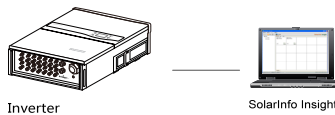

Fig. 6-6 Direct network connection of single inverter

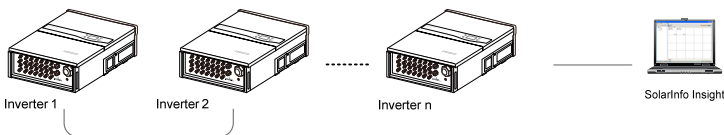

Fig. 6-7 Direct network connection of multiple inverters

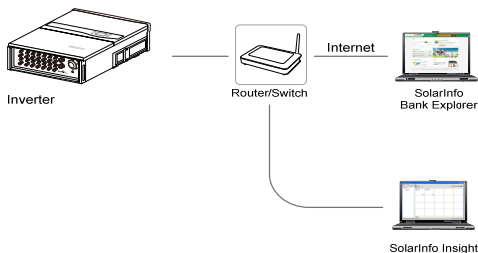

Fig. 6-8 Single inverter network connection

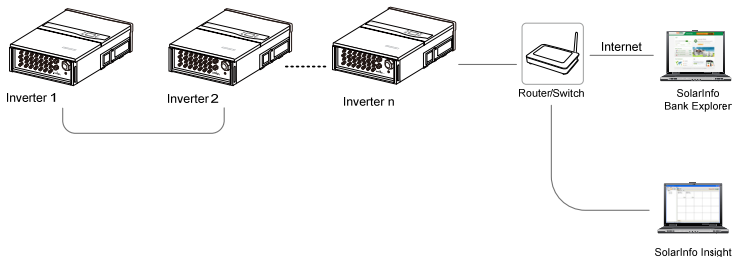

Fig. 6-9 Multiple inverters network connection in daisy chain topology

The network communication of the daisy chain is done via the inverter in-built switching chip. Therefore, when the inverter is damaged, the switching chip cannot work normally and the daisy chain communication will be interrupted.

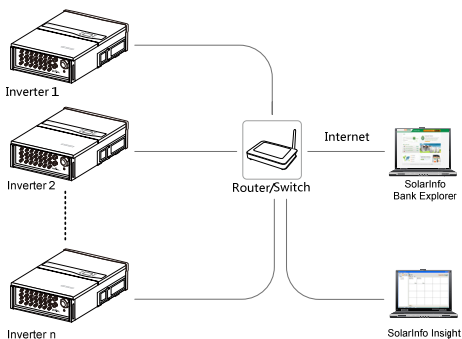

Fig. 6-10 Communication connection in star topology

The maximum number that inverters are connected in the daisy chain depends on converter, data logging device and other factors. Please refer to the manual of converter or data logging device to obtain the limit number.



The network cable should be less than 100m.

NOTICE

Only qualified personnel can set or change Ethernet related parameters.

Ethernet Connection Procedure

Step 1 Lead Network cable through communication cable gland to the configuration circuit board.

Step 2 Use the Ethernet crimper to crimp the cables and connect cables to RJ45 plug according to TIA/EIA 568B.

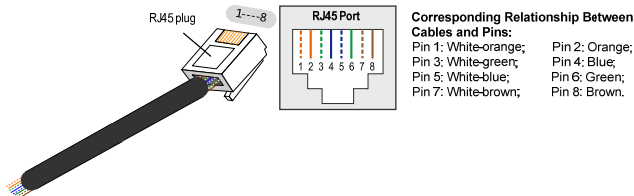

Step 3 Connect the RJ45 plug into the NET in/NET out terminal on the configuration circuit board.

Step 4 According to the position of the inverter (refer to the prior section), repeat step 1...3 to connect the other RS485 cable to the NET in/NET out terminal.

Step 5 Pull cables outwards to confirm whether they are fastened firmly.

Step 6 Tighten the tread-lock sealing lock. Block off the vacant terminals to protect the inverter's internal from dust and moisture.

Step 7 Seal the gaps between the cable and the gland inside the lower part of the cabinet by fireproofing mud. If there is no other connection procedure, reassemble and fix the front cover of the connection cabinet.

Step 8 For the wires which connect to logger or switch, use the Ethernet wire stripper to strip the insulation layer and connect the cable cores to RJ45 plug and then connect to other devices. Refer to other manuals and documents if there are other devices.

Step 9 Confirm the communication connection and set the communication parameters.



If more than one inverter is connected to PC or Logger, please set the communication parameters from the LCD display. For more information, please refer to 10.12 Communication Parameter Setting

7 Commissioning

Commissioning is a critical part for a PV system, which can protect the system from fires, injury and electrical shock.

7.1 Inspection before Commissioning

Before starting the inverter, you should check the following items.

Ambient Environment

1. Inverter is accessible for operation, maintenance and service.
2. Check again to confirm that the inverter is firmly installed onto the wall.
3. Well ventilation.
4. Leave nothing on top of the inverter.
5. Inverter and accessories are correctly connected.
6. Cables are routed in safe place or protected against mechanical damage.
7. Specification of AC circuit breaker is reasonable.
8. Terminals not used underneath the inverter are sealed.
9. Warning signs & labels are suitably affixed and durable.

7.2 Commissioning Procedure

If all checking items mentioned above meet the requirements, precede as follows to start up the inverter for the first time.

Step 1 Close the AC circuit breaker.

Step 2 Rotate DC switch to "ON" position.

Step 3 Suppose there are sufficient sunlight and enough DC power. PV arrays initialize and supply DC power to inverter. The LCD display is activated when DC voltage exceeds inverter startup voltage. If there is a defect on the display, contact Sungrow.

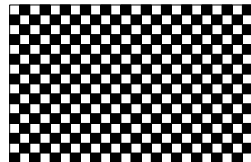

Step 4 Press  to choose country code. Confirm the settings by **Pressing ENTER**.

Country codes										
<input type="radio"/>	GB	<input checked="" type="radio"/>	DE	<input type="radio"/>	FR	<input type="radio"/>	IT	<input type="radio"/>		
<input type="radio"/>	ES	<input type="radio"/>	AT	<input type="radio"/>	AU	<input type="radio"/>	CZ	<input type="radio"/>		
<input type="radio"/>	BE	<input type="radio"/>	DK	<input type="radio"/>	GR	<input type="radio"/>	NL	<input type="radio"/>		
<input type="radio"/>	PT	<input type="radio"/>	CN	<input type="radio"/>	SE	<input type="radio"/>	RO	<input type="radio"/>		
<input type="radio"/>	TH	<input type="radio"/>	TK	<input type="radio"/>	Other	<input type="radio"/>		<input type="radio"/>		

Step 5 Select the country code according to the installation country of the inverter. Each country code represents corresponding local protective parameters that have been preset before delivery. Before country setting, there is warning screen. Operate according to the warning information and press **ENTER**.

Warning!

Only qualified personnel are allowed to adjust following parameters. Improper settings may cause damage to the inverter!



After setting the Country parameter, please proceed to set other parameters of the inverter in accordance with the specific requirements of the local grid. Before commissioning, please check thoroughly if the set parameters meet the local grid requirement.

Refer to “10.11 Protection Parameter Setting” for country code explanation. If the inverter is installed where the country code is not included, please choose item “Other” and manually set the protection parameters.

 CAUTION

If the country code is not set correctly during commissioning, reset the protection parameters as dictated in “10.11 Protection Parameter Setting”. There may be faults if otherwise.

Step 6 If the country code set as GR, a Grid codes page as shown in the right will appear. Press  to select grid code and press **ENTER** to confirm.

GR

Grid codes	
<input checked="" type="radio"/>	GR_L
<input type="radio"/>	GR_JS

If the country code set as DE, a Grid codes page as shown in the right will appear, where LV signifying low-voltage grid; MV signifying medium-voltage grid. **Press** ▼ to select grid code and **press ENTER** to confirm.

DE

Grid codes

LV

MV

If the country code set as TK, a Grid codes page as shown in the right will appear. **Press** ▼ to select grid code and **press ENTER** to confirm.

TK

Grid codes

AG

YG

If the country code set as TH, a Grid codes page special for Thailand will appear. **Press** ▼ to select grid code and **press ENTER** to confirm.

TH

Grid codes

220V

230V

If the country code set as Other, a Grid codes page as shown in the right will appear. **Press** ▼ to select grid code and **press ENTER** to confirm.

Other

Grid codes

50Hz

60Hz

Step 7 If the country selected is not the abovementioned 5 countries, enter the next step directly.

Step 8 After selecting the Grid Code, there will be a "Pro-stage" type selection screen and then corresponding sub-menu will come up. For detailed information, please refer to "10.11 Protection Parameter Setting".

Pro-Stage

Single-stage

Multi-stage

Step 9 Set the inverter time as per local time. Incorrect time setting will affect the data logging. **Press** **>** to move the cursor and **Press** **v** to set the specific time and date. **Press** **ENTER** to confirm setting.

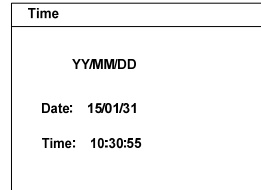

Step 10 After configuring all parameters, there will be a “setting confirmation” screen. Check whether all above-mentioned parameters are correct. Confirm by **Pressing** **ENTER**. Cancel by **Pressing** **ESC** and reset.

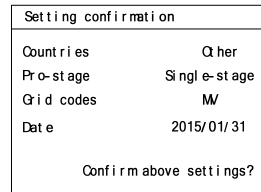

Step 11 Inverter will enter into startup process. Observe the status of LED indicators and the LCD main screen. If commissioning succeeds, the “RUN” indicator will be on and “Run” will be displayed on the “State” area.

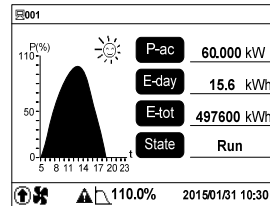

If commissioning fails, the “FAULT” indicator will be on and “Fault” will occur on the display. **Press** **v** to view “current fault” information. Remove the existing fault and then repeat the commissioning procedures.

8 Disconnecting, Dismantling and Disposing the Inverter

8.1 Disconnecting the Inverter

For maintenance work or any service work, inverter must be switched off. During normal operation, switching off is not necessary.

Proceed as follows to disconnect the inverter from DC and AC power sources

Step 1 Disconnect the external AC circuit breaker and prevent it from accidental reconnecting.

Step 2 Rotate the DC switch to the "OFF" position and then pull off all the PV string inputs

NOTICE

Please strictly follow the above sequence. Inverter will not work damage if otherwise.

Step 3 Wait about ten minutes until the capacitors inside the inverter have been discharged.

Step 4 Loose the six screws on the lower connection cabinet and then remove the lid.

Step 5 Measure AC voltage to ground at the AC terminal to confirm AC output voltage of inverter at the AC circuit breaker is zero.

Step 6 Remove the AC cables.

Step 7 Remove the DC cables.

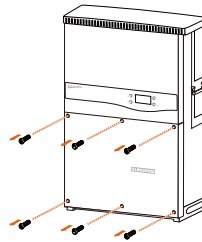

8.2 Dismantling the Inverter

Refer to Chapter 5 and Chapter 6 to dismantle the inverter in reserve steps.

NOTICE

If the inverter will be reinstalled in the future, please refer to “4.4 Inverter Storage” for a proper conservation.

8.3 Disposal of the Inverter

Users should take the responsibility for the disposal of the inverter.

NOTICE

Some parts and devices in the inverter, such as the LCD display, batteries, modules and other components, may cause environment pollution. Users must comply with the related local regulations to avoid pollution.

9 Troubleshooting and Maintenance

9.1 Troubleshooting

9.1.1 Troubleshooting of LED Indicator

Fault type	Troubleshooting
LED indicators and LCD screen are OFF	Disconnect AC side circuit breaker. Rotate DC switch to the "OFF" position. Check the polarity of the PV arrays.
"RUN" indicator id OFF	Disconnect AC side circuit breaker. Rotate DC switch to the "OFF" position. Check the correctness of inverter electrical connection. Check whether DC input voltage exceeds the inverter startup voltage of inverter. If all above conditions are OK, please contact with Sungrow.
"Fault" indicator is ON	A fault is not removed yet. Perform troubleshooting according to fault type in LCD screen. If fault cannot be solved, please contact Sungrow.
"RUN" indicator is blinking	Warning fault occurs of the inverter. Perform troubleshooting according to fault type in LCD screen. If fault cannot be solved, please contact Sungrow.

9.1.2 Troubleshooting of Faults in LCD Screen

When faults occur, "Fault" state will be shown on the main screen. **Press** ▼ to view multiple "current fault" information pages.

Fault Code	Description	Troubleshooting
002	The grid voltage exceeds inverter allowable range. Protection time and protection threshold vary as per different country's requirements.	Check the grid voltage; If the grid voltage exceeds the inverter permissible range, ask utility grid company for solution. If the grid voltage is within the permissible range, contact Sungrow.

Fault Code	Description	Troubleshooting
003	Grid transient voltage exceeds the permissible range	This is a short-term fault due to grid condition. Wait a moment for inverter recovery. If the fault still exists, please contact Sungrow.
004	The grid voltage is below inverter's allowable lower limit. Protection time and protection threshold vary as per different country's requirements.	Check the grid voltage. If the grid voltage exceeds the inverter permissible range, ask utility grid company for solution. If the grid voltage is within the permissible range, contact Sungrow.
005	The grid voltage is too low.	This is a short-term fault due to grid condition. Wait a moment for inverter recovery. If the fault still exists, please contact Sungrow.
006	The AC output current exceeds inverter protection limit.	The inverter will resume if the output current falls below the protection value. If the fault still exists, please contact Sungrow.
007	Transient AC overcurrent	The inverter will self-recover after several seconds.
008	The grid frequency exceeds inverter allowable upper limit.	Check the grid frequency. If the grid voltage exceeds the inverter permissible range, ask utility grid company for solution.
009	The grid frequency is below the inverter allowable lower limit.	If the grid voltage is within the permissible range, contact Sungrow.
010	Islanding	Check whether AC circuit breaker is connected. Check whether AC cables are all firmly connected. Check whether grid is in service. If all conditions are OK and this fault still occurs, contact Sungrow.
011	The DC component of AC current exceeds inverter limit.	Wait for inverter recovery. If the fault still occurs, contact Sungrow.
012	Fault current leakage is detected	Check the PV strings for ground fault. If the fault occurs repeatedly, contact Sungrow.

Fault Code	Description	Troubleshooting
013	Grid abnormal is detected	Wait for inverter recovery. If the grid voltage exceeds the inverter permissible range, ask utility grid company for solution. If the grid voltage is within the permissible range, contact Sungrow.
014	The average grid voltage exceeds the permissible range for over 10 minutes.	Wait for inverter recovery. If the fault occurs repeatedly, contact Sungrow.
015	Grid impedance exceeds inverter's limit	Check the model of the AC cables. Wait for inverter recovery. If the fault occurs repeatedly, contact Sungrow.
016	AC output overloads	Wait for inverter recovery. If the fault occurs repeatedly, contact Sungrow.
017	Grid voltage unbalance	Wait for inverter recovery. If the fault occurs repeatedly, contact Sungrow.
019	The transient bus voltage is high.	Wait for inverter recovery. If the fault occurs repeatedly, contact Sungrow.
020	The bus voltage is high.	Wait for inverter recovery. If the fault occurs repeatedly, contact Sungrow.
021	PV input overcurrent	Check the PV configuration and connection.
023	PV configuration mode has changed during inverter running.	Check the PV configuration; Restart the inverter.
024	Neutral point deviation is detected.	Inverter resumes normal operation when deviation is within the permissible range; If the fault occurs repeatedly, contact Sungrow.
025	Transient unbalance of voltage neutral point	Inverter resumes normal operation when deviation is within the permissible range; If the fault occurs repeatedly, contact Sungrow.
026	Bus voltage fluctuation	This is a short-term fault. Wait for inverter recovery If the fault still occurs, contact Sungrow.
036	Module temperature is too high	Check whether AC output power exceeds the nominal power.

Fault Code	Description	Troubleshooting
037	Ambient temperature is too high.	Check the functionality of the fans. Replace broken fan if necessary. Clean air outlet grills. If the fault still occurs, contact Sungrow.
038	Relay fault	Wait for inverter recovery. If the fault still occurs, contact Sungrow.
039	Inverter insulation resistance fault (ISO-ft)	Wait for inverter recovery. If the fault still occurs, contact Sungrow.
040	AC or DC overcurrent fault, or DC overvoltage fault	Wait for inverter recovery. If the fault occurs repeatedly, contact Sungrow.
041	Current leakage sampling channel failure	Wait for inverter recovery. If the fault still occurs, contact Sungrow.
042	Current imbalance.	If the fault occurs repeatedly, contact Sungrow.
043	ambient temperature falls below -25°C	Disconnect and stop the inverter. Wait for ambient temperature to rise within the permissible range and then restart inverter.
044	DC/AC inversion circuit fault	Wait for inverter recovery. If the fault still occurs, contact Sungrow.
045	PV boost circuit fault	Wait for inverter recovery. If the fault still occurs, contact Sungrow.
047	PV configuration mode set on the display is not in accordance with the reality.	Disconnect the inverter. Re-select PV configuration mode and re-connect PV strings. For more detailed information, please refer to "6.3 PV Array Connection".
048	Phase-R current sampling channel fault.	Wait for inverter recovery. If the fault occurs repeatedly, contact Sungrow.
049	Phase-S current sampling channel fault.	
050	Phase-T current sampling channel fault.	
051	Hardware Overvoltage/Overcurrent protection	Wait for inverter recovery. If the fault occurs repeatedly, contact Sungrow.
070	Fans failure	Stop inverter, disconnect the power supply and remove the broken fan
071	AC side SPD fault	Replace SPD if necessary; Contact Sungrow.
072	DC side SPD fault	
073	Fuse has blown out	Stop inverter, disconnect the power supply and replace the fuse; Contact Sungrow.

Fault Code	Description	Troubleshooting
074	LCD communication fault	A fault has occurred in the internal communication of the inverter. However, the inverter continues feeding into the grid. Contact Sungrow.
075	Solar irradiation is not sufficient for inverter operation.	Wait for sufficient irradiation. If this fault recurs when irradiation is sufficient, check the PV system design and adjust the connection of PV inputs.
076	PV overload	Check the PV system design and adjust the connection of PV inputs.
078	PV power abnormal warning	Check the PV input for disconnection or looseness. If the warning fault still exists, please contact Sungrow
087	AFD block	Wait for inverter recovery. If the fault occurs repeatedly, contact Sungrow.
088	Arc warning	Check the current and press ENTER to remove the warning.
089	AFD failure warning	Restart AFD function through LCD operation.
532-547	PVS reverse polarity warning	Check the PV polarity. If it is connected reversely, reconnect it. If the warning still occurs, contact Sungrow.
548-563	PVS output current abnormal	Check if the PV strings are covered. If the PV strings are clean and uncovered, check the PV module for failure. Check the DC input cable for disconnection. If so, reconnect the cable and reset the PVS function. If the warning still occurs, contact Sungrow.

Device internal hardware fault may cause other unpredictable faults. Therefore, once the hardware fault is removed but other faults occur repeatedly, please contact Sungrow Customer Service Center.

9.2 Maintenance

9.2.1 Routine Maintenance

Item	Method	Period
System clean	Check the temperature and dust of the inverter. Clean the inverter enclosure if necessary. Check if the air inlet and outlet are normal. Clean the air inlet and outlet, if necessary.	Six months to a year (depend on the dust contents in air.)

Item	Method	Period
Fans	Check whether there is crack of the fan blade.	Once a year
	Check whether there is any abnormal noise when the fan is turning. Clean or replace the fans if necessary (see the following section).	
SPD	Check the fuse and DC SPD Replace the fuse (refer to the following section) and DC SPD (contact Sungrow) whenever necessary.	Every Six months

9.2.2 Maintenance Instruction

Fan Maintenance

Fans inside the inverter are used to cool the inverter during operation. If the fans do not operate normally, inverter may not be cooled down and efficiency may decrease. It is therefore necessary to clean the dirty fans and replace the broken fans in time.

DANGER

- **Stop the inverter and disconnect it from all power supplies before maintenance.**
- **Lethal voltage still exists in the inverter. Please wait for at least ten minutes and then perform maintenance work.**
- **Only qualified electricians can maintain the fans.**

Step 1 Disconnect the AC circuit breaker.

Step 2 Rotate the DC switch to the "OFF" position and then pull off all the PV string inputs

Step 3 Wait for at least ten minutes.

Step 4 Disconnect all electrical connection in the reverse procedures in the "6 Electrical Connection".

Step 5 Lift up the inverter.

Step 6 Place the inverter on the platform.

Step 7 Unscrew the bolts as shown in the right picture.

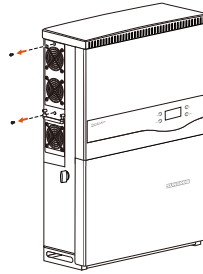

Step 8 Disassemble the metal plate slightly.

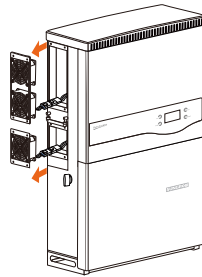

Step 9 Press on the ribbing of the locking hooks and pull the cable outwards.

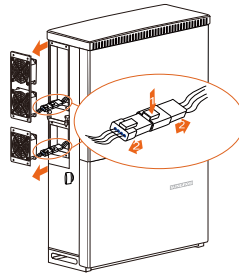

Step 10 Remove the fans out of the inverter.

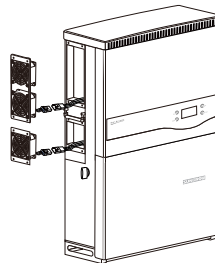

Step 11 Clean the fan with soft brush or vacuum cleaner; or replace the broken fans.

Step 12 Reassemble the fans back into the inverter and restart the inverter.

Replacing the Fuse

Proceed as follows to replace the blown fuse due to over-current:

Step 1 Disconnect the AC circuit breaker.

Step 2 Rotate the DC switch to the "OFF" position and then pull off all the PV string inputs

Step 3 Wait for at least ten minutes.

Step 4 Open the front cover of the inverter junction box.

Step 5 Check using multimeter to identify the blown fuse.

Step 6 Check the corresponding PV strings.

Step 7 Remove the blown fuse.

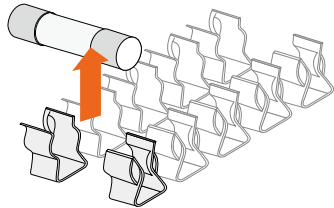

Step 8 Order fuse with the same model and insert the new fuse into the fuse holder.

Step 9 Reassemble the inverter front cover and restart inverter.

Cleaning Air Inlet and Outlet

A huge amount of heat is generated in the process of running the inverter. The inverter adopts a controlled forced-air cooling method.

In order to maintain good ventilation, please check to make sure the air inlet and outlet are not blocked.

Clean the air inlet and outlet with soft brush or vacuum cleaner if necessary.

9.3 Contact Sungrow Service

Should you have any problems in operating on the inverter, please contact us:

Service hotline: +86 551 65327817

Email: service@sungrow.cn (after-sales)

support@sungrowpower.com (technical support)

We need the following information to provide you the best assistance:



- Type of the inverter
- Serial number of the inverter
- Fault code/name
- Brief description of the problem

10 Operation of LCD Display

10.1 Description of Button Function

Inverter offers two buttons for user to look up the running information and configure parameters. The two buttons have multiple functions. Please refer to Tab. 10-1 before any operation onto inverter.

Tab. 10-1 Button function

Button	Operation	Description
	Press for less than 2 seconds	Move upwards or downwards or scroll among set values. Hereinafter, it is referred to as "Press ▼".
	Press for more than two seconds	Return to the previous menu or cancel the command. Hereinafter, it is referred to as "Press ESC ".
	Press for less than 2 seconds	Move left or right, or turn pages. Hereinafter, it is referred to as "Press ▶".
	Press for more than two seconds	Enter into the sub-menu or confirm the command. Hereinafter, it is referred to as "Press ENTER ".



If there is no button operation for:

- 1 minute, LCD backlight is OFF;
- 2 minutes, system returns to the default menu (main screen).

10.2 Menu Tree

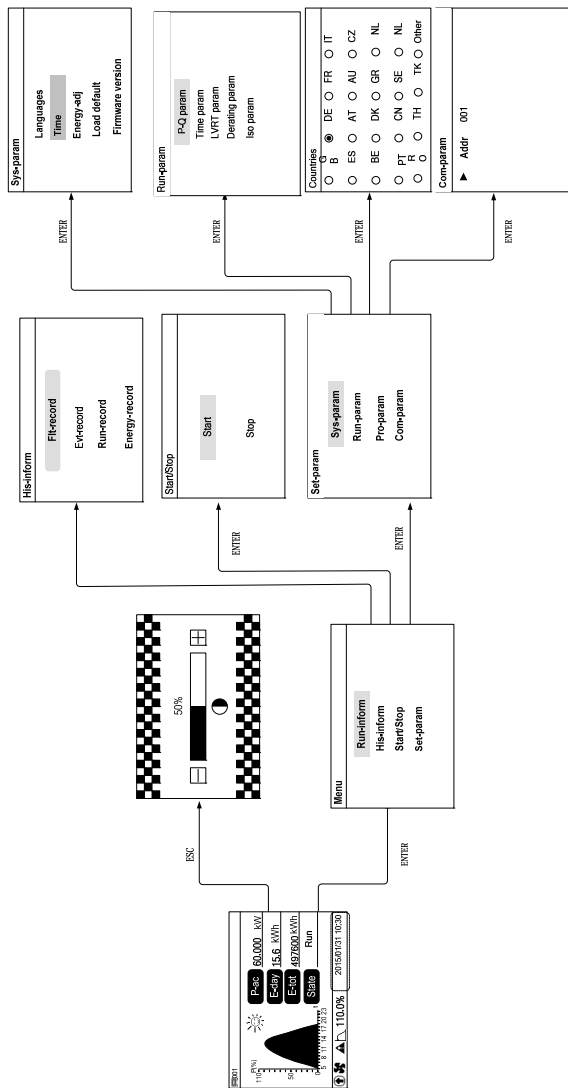

Fig. 10-1 Menu tree

10.3 Main Screen

Once the inverter commissioning is finished, LCD display will enter the main screen as shown in Fig. 10-2.

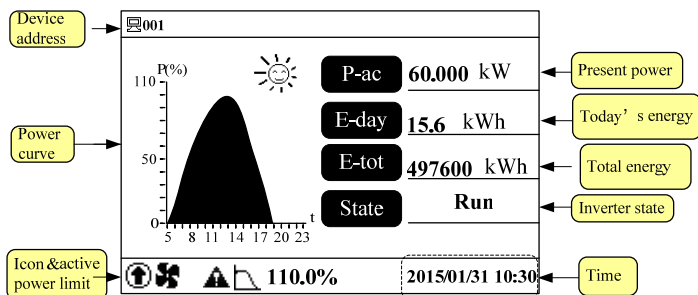

Fig. 10-2 Main screen





Tab. 10-2 Description of the main screen

State	Description
Run	After being energized, inverter tracks the PV arrays' maximum power point (MPP) and converts the DC power into AC power. This is the normal operation mode.
Standby	Inverter enters Standby mode when DC side input is insufficient. In this mode inverter will wait within the Standby duration (set by user, refer to 10.10.1 Main Screen of Run-param).
Stop	Inverter is stopped.
Key-stop	Inverter will stop operation by manual "stop" through LCD menu. In this way, inverter internal DSP stops. To restart the inverter, manually start from the LCD menu.
Start...	The inverter is initializing and synchronizing with the grid.
Upd-fail	IAP upgrade failure
Fault	If a fault occurs, inverter will automatically stop operation, disconnect the AC relay, and display the fault information on the LCD display with the "FAULT" indicator on. Once the fault is removed in recovery time (set by user, refer to 10.10.1 Main Screen of Run-param), inverter will automatically resume running.
Warning	Warning information is detected.

If inverter is in "Fault" state, press \blacktriangleright or \blacktriangledown to view "Current fault" information. To know the meaning of the fault code, please refer to 9.1.2 Troubleshooting of Faults in LCD Screen".

Current fault	PI/I
1 GRID	008

Tab. 10-3 Icon Description

Icon	Description
	Inverter is in IAP update process.
	Inverter in power derating state.
	Fans inside are working.
	Inverter is operating in warning state.

10.4 Contrast Adjustment

Step 1 Press **ESC** to enter into the contrast adjustment screen.

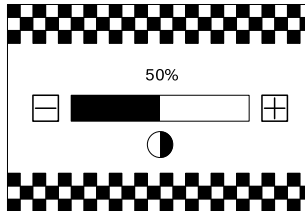

Step 2 Press **▼** to increase the setting value and press **▶** to decrease the value.

Step 3 Press **ENTER** to confirm the contrast setting.



Contrast adjustment range: 0...100%
Recommended value: 50% or 60%.

10.5 Checking Running Information

The main screen displays some basic information about the inverter. For more detailed information, please operate as follows:

Main Screen (Press **ENTER**)→**Menu**→**Run-inform** (Press **ENTER**)

LCD display will show the detailed running information. Scroll pages by pressing **➤** / **⏪**.

DC power input: the total PV input power.

Vdc[V]: DC voltage of each input.

Idc[A]: DC current of each input.

Pdc[W]: DC power of each input.

DC power input	00000W
DC	
Vd[V]	560.0
Idc[A]	10.0
Pdc[W]	00000

Check the DC current of each input.

DC-1: 4.23A	DC-6: 4.23A	DC-11: 6.25A
DC-2: 4.23A	DC-7: 4.23A	DC-12: 6.25A
DC-3: 4.23A	DC-8: 4.23A	DC-13: 6.25A
DC-4: 4.23A	DC-9: 4.23A	DC-14: 6.25A
DC-5: 4.23A	DC-10: 4.23A	

Vac[V]: Phase voltage.

Iac[A]: Phase current.

Pac[W]: AC output of each phase.

F[Hz]: Frequency of each phase.

	L1	L2	L3
Vac[V]	230.0	230.0	230.0
Iac[A]	6.0	6.0	6.0
Pac[W]	0000	0000	0000
F[Hz]	00.00	00.00	00.00

CO₂-reduce: Total CO₂ emission reduction due to the inverter.

E-month: The energy generated in this month.

h-Total: Total running hours of the inverter.

T-today: Inverter running time today.

Temp: Internal temperature of the inverter.

ISO: Insulation resistance to the ground of the input side.

CO ₂ -reduce	0kg
E-month	10kWh
h-Total	1h
T-today	63min
Temp	25.0°C
ISO	30kΩ

P-W: Inverter output active power.

S-Va: Inverter output apparent power.

Country: Inverter selected country code.

Grid code: Inverter selected grid code (note: if country selected is DE, grid code here is LV or MV; country selected is TH, grid code here is 220V or 230V; country selected is TK, grid code here is AG or YG; country selected is Other, grid code here is 50Hz or 60Hz).

P-W	100W
S-Va	130VA
Country	DE
Grid code	LV

10.6 Checking History Information

10.6.1 Checking Running Records

Main Screen (Press **ENTER**)→**Menu** (Press **▼**, Press **ENTER**)→**His-inform** (Press **▼**×2, Press **ENTER**)→**Run-record** (Press **ENTER**)

On the “Run-record” interface, scroll pages by pressing **▶**, and press **▼** to select the date you want to view. Confirm by pressing **ENTER**.

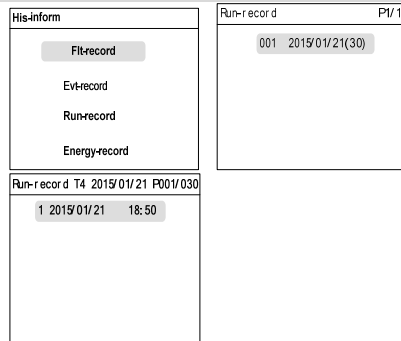

LCD display shows the running records. Press **▶** to turn pages and press **▼** to view the records of the selected date.

DC power input	0000W		L1	L2	L3
DC					
VdV[1]	560.0	VdV[2]	230.0	230.0	230.0
IaI[1]	1.00	IaI[2]	6.0	6.0	6.0
PdP[1]	0000	PdP[2]	0000	0000	0000
		PdP[3]	0000	0000	0000
Power	100W	CO ₂ -reduce	0g		
SVa	130VA	Emoent	130Wh		
Country	DE	InTotal	1h		
Grid code	LV	Thoday	03min		
		Temp	25.0°C		
		ISO	2009A.D		

10.6.2 Checking Fault Records

Main Screen (Press **ENTER**)→**Menu** (Press **▼**, Press **ENTER**)→**His-inform** (Press **ENTER**)→**Flt-record** (Press **ENTER**)

On the “Flt-record” interface, scroll pages forwards by pressing **▶**, and press **▼** to scroll pages backwards.

Flt-r record	P 1/2
001	2015/01/31 10:16:10 [0008]
002	2015/01/31 10:16:10 [0008]
003	2015/01/31 10:16:10 [0008]
004	2015/01/31 10:16:10 [0008]
005	2015/01/31 10:16:10 [0040]



The inverter can only store at most 100 latest fault records.

10.6.3 Checking History Event Records

Main Screen (Press **ENTER**)→**Menu** (Press **▼**, Press **ENTER**)→**His-inform**(Press **▼**, Press **ENTER**)→**His-event** (Press **ENTER**)

On the “Evt-record” interface, scroll pages forwards by pressing **▶**, and press **▼** to scroll pages backwards.

Evt-record	P I/I
001	2015/01/31 10:16:10 Fault



The inverter can only store at most 100 latest fault records.

10.6.4 Checking Energy Records

Main Screen (Press **ENTER**)→**Menu** (Press **▼**, Press **ENTER**)→**His-inform**(Press **▼**, Press **ENTER**)→**Energy-record** (Press **ENTER**)

LCD display shows the energy records. User can view various energy records by pressing **▼**: power curve, daily energy histogram, daily energy histogram, monthly energy histogram, and annual energy histogram.

Energy-record
Power curve
Daily energy histogram
Monthly energy histogram
Annual energy histogram

Power curve: shows the power output from 5am to 11pm in a single day. Each point in the curve is the percentage of present power and nominal power. Press **▶** or **▼** to view the power curve of the latest 7 days.

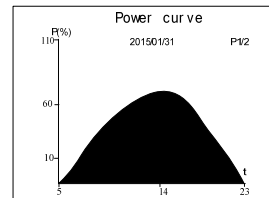

Daily energy histogram: shows the power output every day in the present month. Press **▶** or **▼** to view the daily energy of the latest 12 months.

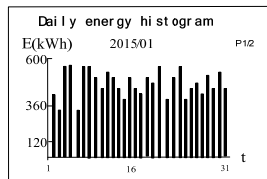

Monthly energy histogram: shows the power output every month in a year. Press **▶** or **▼** to view the monthly energy of the latest 15 years.

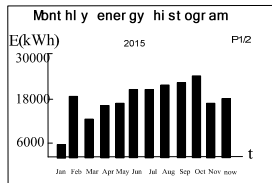

Annual energy histogram: shows the power output every year. Press **▶** or **▼** to view the annual energy of the latest 90 years.

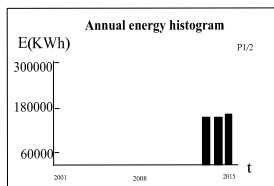

10.7 Starting/Stopping

Main Screen (Press **ENTER**) → Menu (Press **▼** × 2) → Start/Stop (Press **ENTER**)

Press **▼** to choose “Start”/“Stop” and press **ENTER** to confirm the choice.

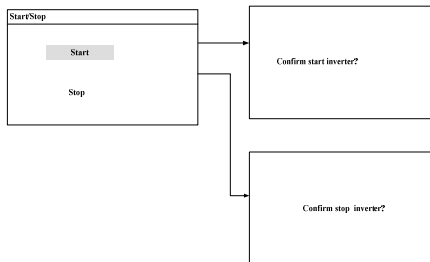

Press **ENTER** to confirm.

10.8 Password Entry

Parameter setting is password-protected. To set the parameters, you should enter the correct password.

Step 1 Press **ENTER** to enter the Menu screen.

Step 2 Press **▼** to move the cursor to “Set-param” item and confirm by **pressing ENTER**.

Step 3 A password confirmation screen will occur.
Press ▶ to move cursor right and **Press ▼** to input the password 111111.

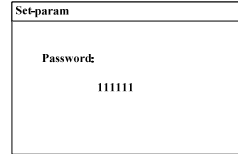

Step 4 Press **ENTER** to confirm the password and enter the “Set-param” sub menu.

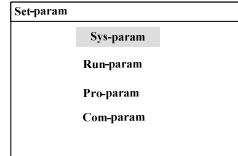

10.9 System Parameter Setting

There are various user settable system parameters. You can set the system parameters after entering the correct password.

10.9.1 Language Setting

Main Screen (Press **ENTER**)→Menu (Press **▼** × 3) →Set-param (Press **ENTER**)→Enter password (Press **ENTER**)→Sys-param (Press **ENTER**, Press **▼**)→Languages (Press **ENTER**)

If Auto is selected for languages, the inverter system language will be the language of the country selected

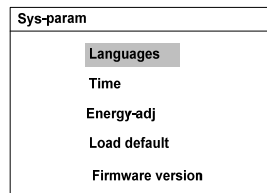

Languages	
<input checked="" type="radio"/>	Auto
<input type="radio"/>	English
<input type="radio"/>	Deutsch
<input type="radio"/>	Francaise
<input type="radio"/>	Italia
<input type="radio"/>	中文

10.9.2 Time Setting

Time deviation between the time on the inverter and the local time of the installation site may cause data logging failure. Please adjust inverter time according to the local time.

Main Screen(Press **ENTER**)→Menu (Press **▼** × 3)→Set-param(Press **ENTER**)→Enter password (Press **ENTER**)→Sys-param(Press **ENTER**, Press **▼**)→Time(Press **ENTER**)

Press **▶** to move the cursor and press **▼** to change value. Press **ENTER** to confirm setting.

Time
YY/MM/DD
Date: 15/01/31
Time: 10:30:55

NOTICE

For user with higher accuracy requirement of the inverter internal clock, time calibration can be performed everyday through the upper computer (or other channel communicated with the device). For details, please refer to the time calibration description in the inverter communication protocol.

Please contact Sungrow if there is still time deviation after calibration.

10.9.3 Total Energy Deviation Adjustment

If the accumulative value "E-total" in the inverter is different from the value in the external metering device, you should adjust energy by "Energy-adj" setting.

Main Screen(Press **ENTER**)→Menu (Press **▼** × 3)→Set-param(Press **ENTER**)→Enter password (Press **ENTER**)→Sys-param(Press **ENTER**, Press **▼** × 2)→Energy-adj(Press **ENTER**)

Press **▶** to move the cursor and press **▼** to change value. Press **ENTER** to confirm setting.
 The positive symbol “+” can be changed to the negative symbol “-”.
 The adjustment range is from -9999 to +9999 kWh.
 (Energy-adj value)= (Real measured value) - (E-tot reading value).

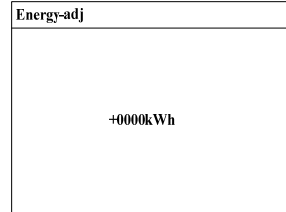

10.9.4 Load Default

NOTICE

All history information will be unrecoverable cleared and all parameters will return to the default value except the protective parameters and time once the “load default” operation is performed.

Main Screen (Press **ENTER**)→Menu (Press **▼**×3)→Set-param(Press **ENTER**)→Enter password (Press **ENTER**)→Sys-param(Press **ENTER**, Press **▼**×3)→Load default (Press **ENTER**)

Press **ENTER** to confirm “load default”.

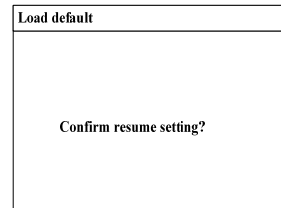

10.9.5 Checking Firmware Version

Main Screen (Press **ENTER**)→Menu (Press **▼** ×3)→Set-param(Press **ENTER**)→Enter password (Press **ENTER**) → Sys-param(Press **ENTER**, Press **▼**×4) → Firmware version(Press **ENTER**)

Inverter shows detailed firmware information, including LCD version and DSP version.
 The firmware version information is read only.

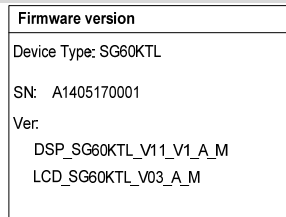

10.10 Running Parameter Setting

10.10.1 Main Screen of Run-param

Main Screen (Press **ENTER**)→Menu (Press **▼** ×3)→Set-param (Press **ENTER**)→Enter password (Press **ENTER**, Press **▼**)→Run-param (Press **ENTER**)

On the “Run-param” screen, press **▼** to select one item and press **ENTER** to enter the setting interface.

For each item, **Press ▶** to move the cursor and **Press ▼** to set the appropriate value.

Confirm settings by Pressing **ENTER**.

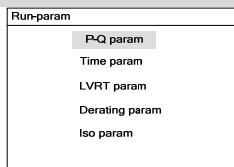

User can only check the running parameter in this interface. The default values of the running parameters have been preset as per grid code of corresponding countries. To set the running parameter, please contact Sungrow to acquire advanced password.

Tab. 10-4 Description of Running Parameters

Parameter	Description	Default	Range
P-W limits	Inverter active power limitation	110.0%	0~110%
Rate limit	Set the active power change rate. When it is set to [ON], user can set the raise and decline rate.	[OFF]	[OFF]/ [ON]
Power raise	When Rate limit is ON, set the active power rise rate.	100%/min	8~100%/min
Power Decline	When Rate limit is ON, set the active power decline rate.	6000%/min	8~6000%/min
Fault slowup	Set the power rise rate when a fault is removed. When it is ON, the active power raise rate can be set.	[ON]	[OFF]/ [ON]
Slowup rate	Set the active power raise rate.	100%/min	8~100%/min
Save P-W Setting	Whether to save the active power setting	[OFF]	[OFF]/ [ON]
Save Q-Var setting	Whether to save the reactive power setting	[ON]	[Pt]/[Qt]/ [Off] / [Q(P)] / [Q(U)]

Parameter		Description	Default	Range
	Q-Var witch	Set the reactive power regulation function	[OFF]	[OFF]/ [ON]
	PF	Inverter output power factor	+1.000	-1.000~-0.800/ +0.800~+1.000
	Q-Var limits	Inverter reactive power limitation	0.0%	0~+100%/ 0~-100%
Time param	Standby time	Time from inverter standby to startup	20s	20~255s
	Recover time	Time from inverter fault is removed to standby	30s [IT: 300s]	0-900s
LVRT param		Set the LVRT to OFF or ON. When it is ON, inverter can keep grid-connection for a certain time when grid fault occurs and provide reactive power for grid recovery.	[OFF]	[OFF]/ [ON]
Derating param		Set the Derating param to OFF or ON. If it is ON, inverter will operate with power derating when grid frequency exceeds the set value.	[OFF]	[OFF]/ [ON]
Iso param	ISO	Set the ISO protection function to ON or OFF. When it is ON, inverter will not connect to the grid when resistance to the ground is below the set value.	[ON]	[OFF]/ [ON]
	ISO pro value	Set the resistance to the ground.	30K Ω	20~3000K Ω

10.10.2 Active/Reactive Power Parameters

Main Screen (Press **ENTER**)→**Menu** (Press **▼** ×3)→**Set-param** (Press **ENTER**)→**Enter password** (Press **ENTER**, Press **▼**)→**Run-param** (Press **ENTER**) →**P-Q Param** (Press **ENTER**)

P-Q Param	
▶ P-W limits	110.0%
Rate limit	[ON/OFF]
Power raise	100%/min
Power decline	6000%/min
Fault slowup	[ON/OFF]
Slowup rate	10%/min

P-Q param	
▶ Q-Var switch	[OFF]
RF	+1.000
Q-Var limits	+100.0%

10.10.3 Reactive Power Regulation

Inverter provides reactive power regulation function. Use the “**Q-Var switch**” parameter to activate this function and select proper regulation mode.

Tab. 10-5 Explanation of reactive power regulation switch

Regulation Mode	Explanation
Pf	The reactive power can be regulated by the parameter <i>PF (Power Factor)</i> .
Qt	The reactive power can be regulated by the parameter <i>Q-Var limits (in %)</i> .
Off	The <i>PF</i> is limited to +1.000, and the “ <i>Q-Var limits</i> ” is limited to 0.0%.
Q(P)	The <i>PF</i> changes with the output power of the inverter.
Q(U)	The reactive power changes with the grid voltage.

“PF” Mode

The reactive power can be regulated by the parameter *PF* on the Run-param screen.

“Qt” Mode

The reactive power can be regulated by the parameter *Q-Var limits (in %)* on the Run-param screen.

“Off” Mode

Reactive power cannot be regulated. The *PF* is limited to +1.000, and the *Q-Var limit* is limited to 0.0%.

“Q(P)” Mode(when the country selection is not “IT”)

PF changes with the inverter output power.

If the country selection is not “IT” (Italy), after selecting Q(P) Mode, **Press** \blacktriangledown to enter the Run-param-Q(P) submenu.

For each item setting, **Press** \blacktriangleright to move cursor and **Press** \blacktriangledown to set the appropriate value. Confirm settings by Press **ENTER**.

Run-param-Q(P)	
Upper PF Cap	1.000
Lower Power	050.0%
Lower PF Ind	0.900
Upper Power	100.0%

Tab. 10-6 “Q(P)” Mode Parameters Explanation

Parameter	Explanation	Default	Range
Upper PF Cap	Power factor of point P1 in the Q(P) mode curve	1	0.9~1
Lower Power*	Output power of point P1 in the Q(P) mode curve (in %)	50%	0%~50%
Lower PF Ind	Power factor of point P2 in the Q(P) mode curve	0.9	0.9~1
Upper Power*	Output power of point P2 in the Q(P) mode curve (in %)	100%	50%~100%

* Lower Power < Upper Power

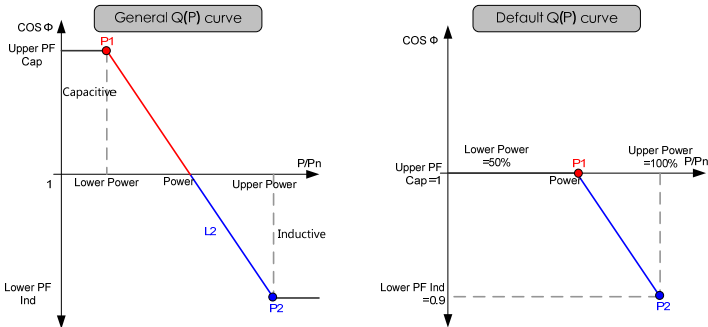

Fig. 10-3 Reactive Power Regulation Curve in Q(P) Mode

“Q(U)” Mode(when the country selection is not “IT”)

The reactive power ratio changes with the grid voltage.

If the country selection is not “IT” (Italy), after selecting Q(U) mode, **Press** \blacktriangledown to enter the Run-param-Q(U) submenu.

For each item setting, **Press** \blacktriangleright to move cursor and **Press** \blacktriangledown to set the appropriate value.

Confirm settings by Pressing **ENTER**.

Run-param-Q(U)	
▶ Lower Q/Sn Ind	050.0%
Upper Q/Sn Cap	050.0%
Lower U Limit	095.0%
Upper U Limit	115.0%
▼	
Run-param-Q(U)	
▶ U1 Limit	095.0%
U2 Limit	105.0%
Hysteresis	3.0%

Tab. 10-7 “Q(U)” Mode Parameters Explanation

Parameter	Explanation	Default	Range
Lower Q/Sn Ind	Inductive Q/Sn value of point P4 in the Q(U) mode curve	25%	0%~50%
Upper Q/Sn Cap	Capacitive Q/Sn value of point P1 in the Q(U) mode curve	25%	0%~50%
Lower U Limit	Grid voltage limit (in %) of point P1 in the Q(U) mode curve	80%	80%~90%
Upper U Limit	Grid voltage limit (in %) of point P4 in the Q(U) mode curve	115%	110%~115%
U1 Limit*	Grid voltage limit (in %) of point P2 in the Q(U) mode curve	95%	95%~100%
U2 Limit*	Grid voltage limit (in %) of point P3 in the Q(U) mode curve	105%	100%~105%
Hysteresis*	Hysteresis voltage width (in %)	3%	0%~5%

* $U1 \text{ Limit} + \text{Hysteresis} < U2 \text{ Limit} - \text{Hysteresis}$

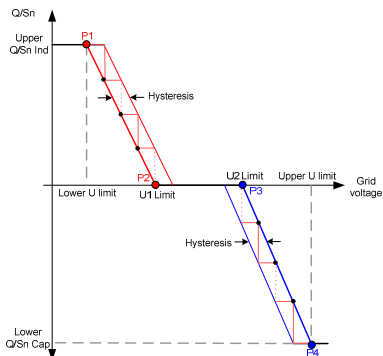

Fig. 10-4 Reactive Power Regulation Curve in Q(U) Mode

10.10.4 Reactive Power Setting for Italy

If the “Countries” selected is “IT” (Italy), several LCD menus and operation methods are different from other countries.

The differences focus on “Run-param” as shown below.

Italy “Q(P)” Mode

Power factor changes with the output power of the inverter.

Select Q(P) mode and **Press** ▼ to enter into the “Run-para-Q(P)” sub-menu.

Press ▼ to move the cursor; **Press** ▶ to enter the editing mode, then the selected parameter will be shaded.

Press ▼ to increase one-step value; **Press** ▶ to decrease one-step value.

Press ENTER to confirm the setting and exit from the editing mode.

Run-param-Q(P)	F3/3
▶ PA	020.0%
PB	050.0%
PC	100.0%
Pf max	0.900
Uin	105.0%
Uout	100.0%

Tab. 10-8 Italy “Q(P)” Mode Parameters Explanation

Parameter	Explanation	Default	Range	Step
PA*	Active power at point A (in %)	20%	20~100%	1%
PB*	Active power at point B (in %)	50%	20~100%	1%
PC*	Active power at point C (in %)	100%	20~100%	1%
Pf max	Power factor at point C	0.9	0.9~1	0.01
Uin**	Enter Q(P) regulation mode when grid voltage is above Uin	105%	100~110%	1%
Uout**	Exit from the Q(P) regulation mode when grid voltage is below Uout	100%	90~100%	1%

*PA < PB ≤ PC ** Uin > Uout

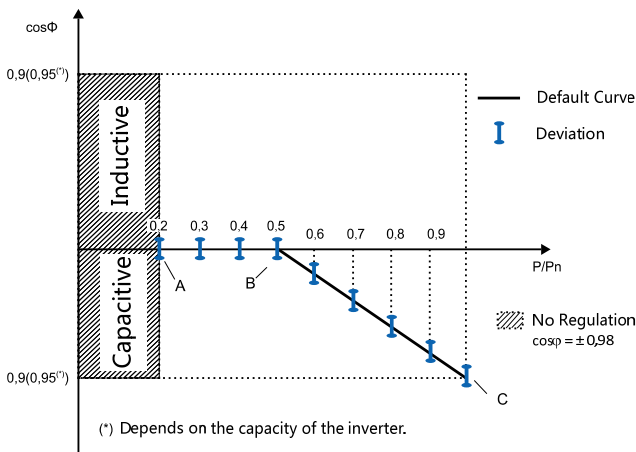

Fig. 10-5 Reactive Power Regulation Curve in "IT" Q(P) Mode

Italy "Q(U)" Mode

The reactive power ratio changes with the grid voltage.

Select Q(U) mode and **Press** ▼ to enter the "Run-para-Q(U)" sub-menu.

Press ▼ to move the cursor; **Press** ► to enter the editing mode, then the selected parameter will be shaded.

Press ▼ to increase one-step value; **Press** ► to decrease one-step value.

Press ENTER to confirm the setting and exit from the editing mode.

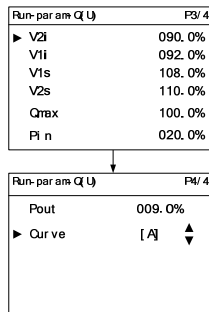

Tab. 10-9 Italy "Q(U)" Mode Parameters Explanation

Parameter	Explanation	Default	Range	Step
V2i*	Grid voltage at point D (in %)	90%	90~110%	1%
V1i*	Grid voltage at point C (in %)	92%	90~110%	1%
V2s*	Grid voltage at point A (in %)	108%	90~110%	1%
V1s*	Grid voltage at point B (in %)	110%	90~110%	1%
Qmax	The max. ratio of reactive power (in %)	90%	50~100%	1%
Pin**	Enter the Q(U) regulation mode when power is above Pin	20%	20~100%	1%
Pout**	Exit from the Q(U) regulation mode when power is below Pout	9%	1~20%	1%

Parameter	Explanation	Default	Range	Step
Curve	Curve type	A	A/B	-

* $V_{2i} < V_{1i} < V_{1s} < V_{2s}$ ** $P_{in} > P_{out}$

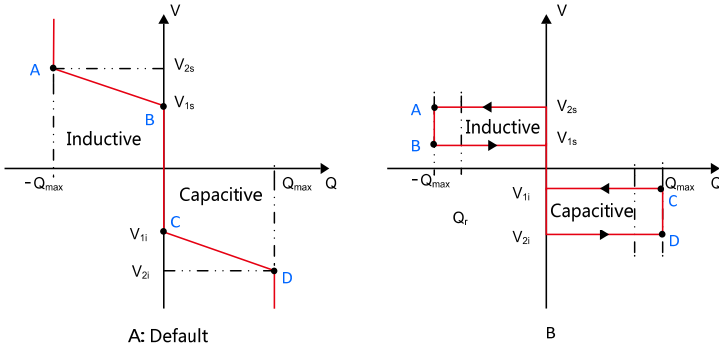
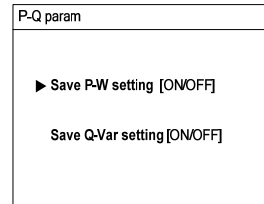

Fig. 10-6 Reference Reactive Power Regulation Curve in "IT" Q(U) Mode

10.10.5 Save P/Q-set

On the "Save P/Q-set" screen, Press \blacktriangledown to move arrow to one item, Press \blacktriangleright to move cursor and Press \blacktriangledown to set.
 Confirm by Pressing **ENTER**.
 Select "ON" to save the values set after power down.
 Select "OFF" to restore default values after power down.



10.10.6 Time Parameters

Main Screen (Press **ENTER**) → Menu (Press \blacktriangledown ×3) → Set-param (Press **ENTER**) → Enter password (Press **ENTER**, Press \blacktriangledown) → Run-param (Press **ENTER**, Press \blacktriangledown) → Time-param (Press **ENTER**)

Time-param	
Standby time	020s
Recovery time	000s

10.10.7 LVRT Parameter

Main Screen (Press **ENTER**) → Menu (Press **▼** ×3) → Set-param (Press **ENTER**) → Enter password (Press **ENTER**, Press **▼**) → Run-param (Press **ENTER**, Press **▼** ×2) → LVRT param (Press **ENTER**)

LVRT param	
LVRT	[ON/OFF]
LVRT kf	02
LVRT normal volt	195.5V
LVRT T1	300.00S
LVRT tolera volt	34.5V
LVRT T2	0.62S

10.10.8 Derating Parameters

Main Screen (Press **ENTER**) → Menu (Press **▼** ×3) → Set-param (Press **ENTER**) → Enter password (Press **ENTER**, Press **▼**) → Run-param (Press **ENTER**, Press **▼** ×3) → Derating param (Press **ENTER**)

Derating param	
► Fre-Derating	[ON/OFF]
F1	50.00Hz
P1	100%
F2	50.20Hz
P2	100%
F3	52.00Hz
P3	100%

10.10.9 ISO Parameters

Main Screen (Press **ENTER**) → Menu (Press **▼** ×3) → Set-param (Press **ENTER**) → Enter password (Press **ENTER**, Press **▼**) → Run-param (Press **ENTER**, Press **▼** ×4) → ISO param (Press **ENTER**)

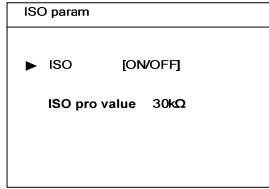

10.11 Protection Parameter Setting

Protection parameters are designed for the threshold value that can trigger the protection function of the inverter.

Main Screen (Press **ENTER**)→Menu (Press **▼**×3)→Set-param (Press **ENTER**)→Enter password (Press **ENTER**, Press **▼**×2)→Pro-param (Press **ENTER**)

Press **▶** to move cursor and Press **▼** to input the password.



User can only check the parameter in this interface. The default values of the protection parameters have been preset as per grid code of corresponding countries.
To set the protection parameter, please contact Sungrow to acquire advanced password.

10.11.1 Country Setting

To make the protection parameters setting convenient, inverter provides in-built protection parameters for certain countries.

Press **▼** to choose countries and press **ENTER** to confirm.

If the country selected is not in the list, please choose Other and then input the protection parameters manually.

Countries									
<input type="radio"/>	GB	<input checked="" type="radio"/>	DE	<input type="radio"/>	FR	<input type="radio"/>	IT		
<input type="radio"/>	ES	<input type="radio"/>	AT	<input type="radio"/>	AU	<input type="radio"/>	CZ		
<input type="radio"/>	BE	<input type="radio"/>	DK	<input type="radio"/>	GR	<input type="radio"/>	NL		
<input type="radio"/>	PT	<input type="radio"/>	CN	<input type="radio"/>	SE	<input type="radio"/>	NL		
<input type="radio"/>	RO	<input type="radio"/>	TH	<input type="radio"/>	TK	<input type="radio"/>	Other		

Tab. 10-10 Country code description

Country Code	Country	Language
GB	Great Britain	English
DE	Germany	German
FR	France	French
IT	Italy	Italian
ES	Spain	English
AT	Austria	German
AU	Australia	English
CZ	Czech	English

Country Code	Country	Language
BE	Belgium	French
DK	Denmark	English
GR	Greece	English
NL	Netherlands	English
PT	Portugal	English
CN	China	Chinese
SE	Sweden	English
RO	Romania	English
TH	Thailand	English
TK	Turkey	English
Other	Country not mentioned above	English

When the country selected is TH, TK, DE, GR or Other, the grid code specific to them will appear on the LCD display as shown below. Press **▼** to choose grid code and press **ENTER** to confirm.

GR

Grid codes

GR_L

GR_JS

DE

Grid codes

LV

MV

TK

Grid codes

AG

YG

TH

Grid codes

220V

230V

Other

Grid codes

50Hz

60Hz

If country selected is not the five countries mentioned above, you need not to choose grid code. The Pro-Stage interface will appear. You may choose Single-stage or Multi-stage. Press **▼** to choose single-stage or Multi-stage and press **ENTER** to confirm.

Pro-Stage

Single-stage

Multi-stage

10.11.2 Single-stage Protection Parameter Setting

The following interfaces will appear if Single-stage is selected.

Press ▼ to select parameter, **Press** ▶ to move cursor and **Press** ▼ to set the appropriate value. Confirm settings by Pressing **ENTER**.

Pro-param Single	
▶ Vgrid-max	276.0V
Vgrid-min	184.0V
Fgrid-max	51.50Hz
Fgrid-min	49.80Hz

10.11.3 Multi-stage Protection Parameter Setting

The following interfaces will appear if Multi-stage is selected.

Press ▼ to select parameter, **Press** ▶ to move cursor and **Press** ▼ to set the appropriate value. Confirm settings by Pressing **ENTER**.

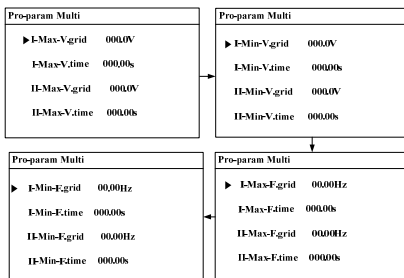

Tab. 10-11 Multi-stage Protection Parameters Explanation

Parameter	Explanation
Max-V. prot	Over-voltage protection
I -Max-V. grid	Stage I Grid over-voltage (U>)
I -Max-V. time	Stage I Grid over-voltage (U>) tripping time
II -Max-V. grid	Stage II Grid over-voltage (U>>)
II -Max-V. time	Stage II Grid over-voltage (U>>) tripping time
Min-V. prot	Under-voltage protection
I -Min-V. grid	Stage I Grid under-voltage (U<)
I -Min -V. time	Stage I Grid under-voltage (U<) tripping time
II -Min -V. grid	Stage II Grid under-voltage (U<<)
II -Min -V. time	Stage II Grid under-voltage (U<<) tripping time
Max-F. prot	Over-frequency protection
I -Max-F. grid	Stage I Grid over-frequency (f>)
I -Max-F. time	Stage I Grid over-frequency (f>) tripping time
II -Max-F. grid	Stage II Grid over-frequency (f>>)
II -Max-F. time	Stage II Grid over-frequency (f>>) tripping time

Parameter	Explanation
Min-F. prot	Under-frequency protection
I -Min-F. grid	Stage I Grid under-frequency (f<)
I -Min -F. time	Stage I Grid under-frequency (f<) tripping time
II -Min -F. grid	Stage II Grid under-frequency (f<<)
II -Min -F. time	Stage II Grid under-frequency (f<<) tripping time

10.11.4 Protection Recovery Setting

After setting the protection parameters, inverter enters protection recovery interface.

Pro-recover
▶ Vmax-recover 240.0V
Vmin-recover 220.0V
Fmax-recover 50.10Hz
Fmin-recover 49.50Hz

Tab. 10-12 Description of protection recovery parameters

Parameter	Explanation
Vmax-recover	Max. protection recovery voltage
Vmin-recover	Min. protection recovery voltage
Fmax-recover	Max. protection recovery frequency
Fmin-recover	Min. protection recovery frequency

10.11.5 Protection Parameter Confirmation

The setting confirmation interface will appear once the protection parameters are input. Press **ENTER** to confirm the parameter selection and press **ESC** to reset the protection parameters.

Setting confirmation	
Countries	Other
Pro-stage	Single-stage
Grid codes	MV
Date	2015/01/31
Confirm above settings?	

10.12 Communication Parameter Setting

Main Screen (Press **ENTER**)→Menu (Press **▼** ×3)→Set-param (Press **ENTER**)→Enter password (Press **ENTER**, Press **▼** ×3)→Com-param (Press **ENTER**)

Press **▶** to move cursor and press **▼** to set the appropriate value. Confirm settings by Pressing **ENTER**.

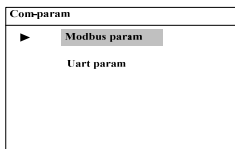

Device address range: 1-247.

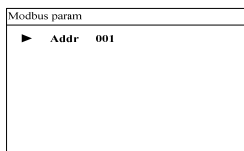

Baud rate can be set to 9600bps or 19200bps.

Parity can be set to NO, ODD or EVEN. Stop bit can be set to 1b or 2b.

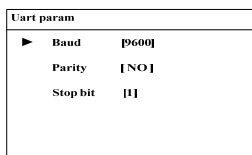

10.13 Advanced Parameters Setting

The inverter provides a variety of advanced protection features.

Main Screen (Press **ENTER**) → Menu (Press **▼** ×3) → Set-param (Press **ENTER**) → Enter password (Press **ENTER**, Press **▼** ×4) → Advanced settings (Press **ENTER**)



User can only check the parameter in this interface. The default values of the advanced parameters have been preset as per grid code of corresponding countries. To set the advanced parameters, please contact Sungrow to acquire advanced password.

10.13.1 PVS Detect Settings

Main Screen (Press **ENTER**) → Menu (Press **▼** ×3) → Set-param (Press **ENTER**) → Enter password (Press **ENTER**, Press **▼** ×4) → Advanced settings (Press **ENTER**) → PVS Detect

A password confirmation screen will occur. Press **▶** to move cursor right and Press **▼** to input the password 111111.

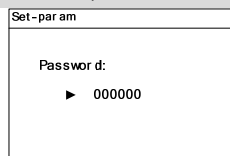

PVS Detect represents the PV strings current abnormal conditions detection. Press **ENTER** to confirm.

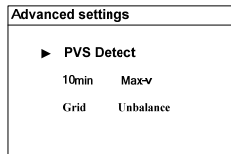

Press **▼** to select PVS Detect function settings. Press **ENTER** to confirm the selection.

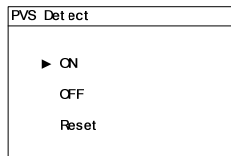

When the PV inputs are changed, the corresponding “fault” state will be shown on the main screen. You can perform the PVS Detect Reset function to re-detect the PV input strings number.

10.13.2 10min Max-V

Main Screen(Press **ENTER**)→Menu (Press **▼**×3)→Set-param (Press **ENTER**)→Enter password (Press **ENTER**, Press **▼**×4)→Advanced settings(Press **ENTER**, Press **▼**)→10min Max-V

A password confirmation screen will occur. Press **▶** to move cursor right and Press **▼** to input the password 111111.

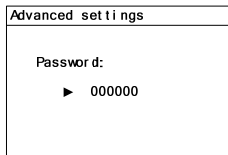

Press **ENTER** to confirm.

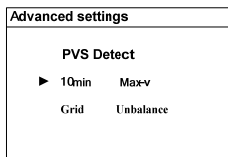

Press **▼** to select 10min Max-V function settings, set the over-voltage protection point in 10min. Press **ENTER** to confirm the selection.

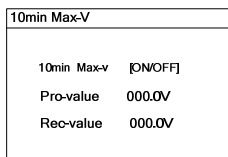

10.13.3 Grid Unbalance

Main Screen(Press **ENTER**)→Menu (Press **▼**×3)→Set-param (Press **ENTER**)→Enter password (Press **ENTER**, Press **▼**×4)→Advanced settings(Press **ENTER**, Press **▼**×2)→Grid Unbalance

Press **▼** to select and set the grid voltage unbalance protection point. Confirm the selection by Pressing **ENTER**.

Grid Unbalance	
▶ Grid Unbalance	[ON/OFF]
Amplitude	10%
Pro-time	05.00S

11 Appendix

11.1 Technical Data

Parameters	SG60KTL
Input Side Data	Connection to 400Vac grid
Max. PV input voltage	1000V
Startup voltage	620V
MPP voltage range	570~950V
MPP voltage range for nominal power	570~850V
No. of MPPT(s)	1
Max. number of PV strings per MPPT	14
Max. PV input current	120A
Max. input current for input connector	12A
Short-circuit current of PV input	140A
Max. inverter backfeed current to the array	0A
Output Side Data	
Nominal AC output power	60000W
Max. AC output apparent power	66000VA
Max. AC output power	66000W
Max. AC output current	96A
Nominal AC voltage	3/N/PE, 230/400Vac
AC voltage range	310~480Vac
AC connected Inrush current(Peak/Duration)	70A/0.05ms
Maximum output fault current	102A
Maximum output overcurrent protection	220A
Nominal grid frequency	50Hz/60Hz
Grid frequency range	45~55Hz/ 55~65Hz
THD	< 3% (at nominal power)
DC current injection	<0.5%I _n

Parameters	SG60KTL
Power factor	>0.99 default value at nominal power (adj. 0.8 overexcited...0.8 underexcited)
Protection	
Islanding protection	Yes
LVRT	Yes
AC short circuit protection	Yes
Leakage current protection	Yes
PV string current monitoring	Yes
DC switch	Integrated
DC fuse	Integrated
Overvoltage protection	DC Type II; AC Type III
System data	
Max. efficiency	99.0%
Max. European efficiency	98.7%
Isolation method	Transformerless
Ingress protection rating	IP65
Night power consumption	<1W
Operating ambient temperature range	-25~ + 60°C (>50°C derating)
Allowable relative humidity range	0~100%
Cooling concept	Smart forced air cooling
Max. operating altitude	4000m (>3000m derating)
Display	Graphic LCD
Communication	RS485
DC terminal	MC4
AC terminal	Screw-crimp terminal
Certification	VDE0126-1-1,EN62109-1,EN62109-2,G59/3,CEI-021,AS/NZS 3100,AS4777.2,AS4777.3,VDE-AR-N-4105,BDEW, CGC
Mechanical Data	
Dimensions (W×H×D)	634×959×267mm
Mounting method	Wall bracket
Weight	55kg

11.2 Exclusion of Liability

The content of these documents is periodically checked and revised where

necessary. Please call us or check our website www.sungrowpower.com for the latest information. No guarantee is made for the completeness of these documents. Please contact our company or distributors for the latest version.

Guarantee or liability claims for damages of any kind are excluded if they are caused

- Improper or inappropriate use or install of the product
- Install or operate the product in unintended environment
- Install or operate the product without observing relevant safety regulations in the deployment location
- Ignore the safety warnings or instructions contained in all documents relevant to the product
- Install or operate the product under incorrect safety or protection conditions
- Alter the product or supplied software without authority
- Product malfunctions due to operation attached or neighboring devices running out of the allowed limit values
- Unforeseen calamity or force majeure
- The use of supplied software produced by Sungrow Power Supply Co., Ltd.. is subject to the following conditions:
 - Sungrow Power Supply Co., Ltd. assumes no liability for direct or indirect damages arising from the use of SolarInfo software. This also applies to the provision or non-provision of support activities.
 - SolarInfo software used for commercial purposes is prohibited.
 - Decompiling, decoding or destroying the original program, including SolarInfo software and the embedded software, is prohibited.

11.3 About Us

Sungrow power supply is a Chinese leading manufacturer of various power electronics products for renewable energy generation systems. Our products include converters, inverters, battery chargers and other power supplies for distributable generation systems in both grid-connected and stand-alone applications. The power rating of SUNGROW products covers a range from several hundred watts to large mega-watt systems.

The pursuit of SUNGROW is to help our customers acquire stable and clean power with minimum cost, maximum reliability and enhanced safety.

11.4 Contact Information

Should you have any questions or queries about this product, please contact us through the following information. We will be more than happy to assist you!

Company	Sungrow Power Supply Co., Ltd.
Address	No.1699 Xiyou Rd.,New & High Technology Industrial Development Zone, Hefei, P. R. China
Zip	230088
Sales tel.	+86 551 6532 7834/6532 7845
Fax	+86 551 6532 7856
Website	www.sungrowpower.com
Email	sales@sungrowpower.com (sales) support@sungrowpower.com (technical support) service@sungrowpower.com (after-sales service)



Green and Effective

Sungrow Power Supply Co., Ltd.

Add: No.1699 Xiyou Rd.,New & High Technology Industrial Development Zone, 230088,Hefei, P. R. China.

Post Zip: 230088

Web: www.sungrowpower.com

E-mail: info@sungrow.cn

Tel: +86 551 6532 7834/6532 7845

Fax: +86 551 6532 7856

Specifications are subject to changes without advance notice.